

BERNINA®

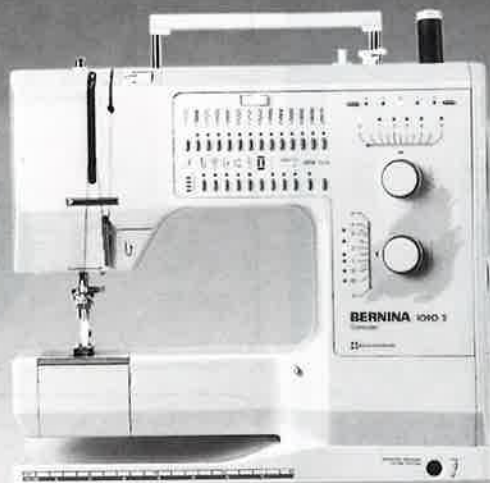

BERNINA® 1090S

GB



BERNINA® 1090S

GB

Indicator/Control panel

- 1-14 Practical stitches
- 15-28 Decorative stitches
- 29 Toggle switch
- 30 Presser foot indicator
- 31 Needle stop down
- 32 1/2 speed
- 33 Reverse sewing button
- 34 Single pattern/pattern end
- 35 Mirror image
- 36 Buttonhole
- 37 Long stitch
- 38, 39 Balance
- 40 Memory button
- 41 Clear button
- 42 Needle position buttons
- 43 Basic settings indication lamps for stitch width
- 44 Stitch width bar
- 45 Stitch width indication lamp
- 46 Stitch width knob
- 47 Basic settings indication lamps for stitch length
- 48 Stitch length bar
- 49 Stitch length indication lamp
- 50 Stitch length knob

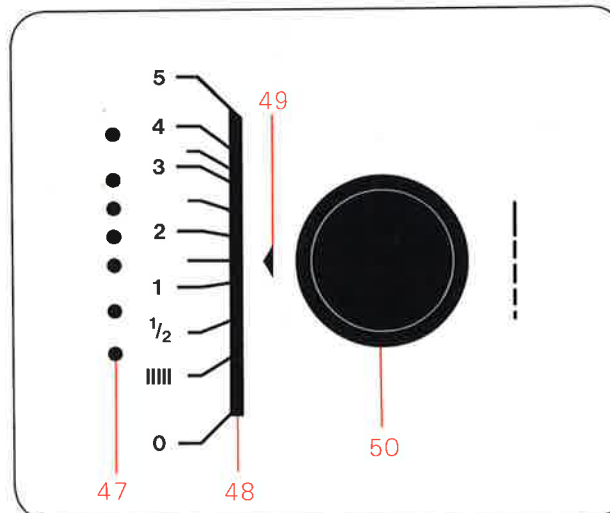
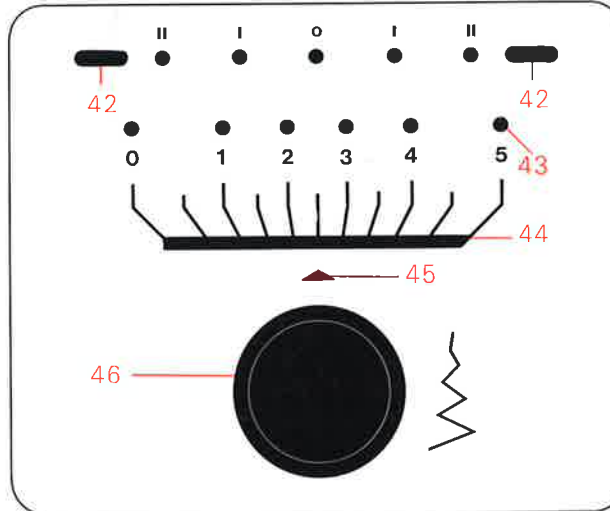
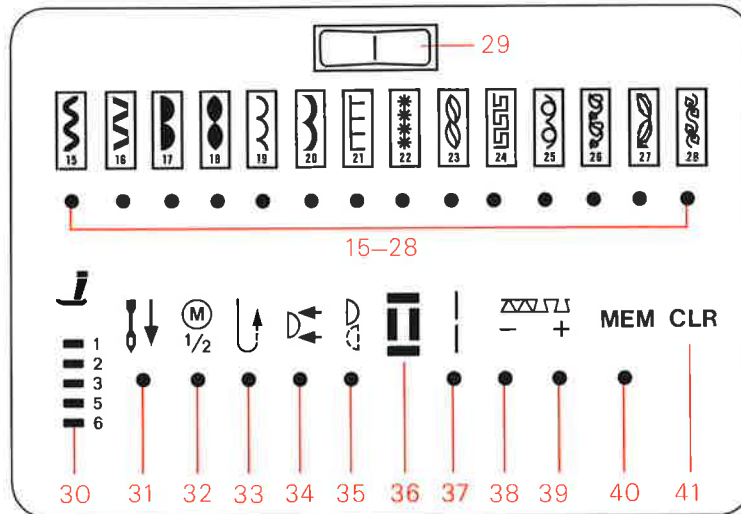
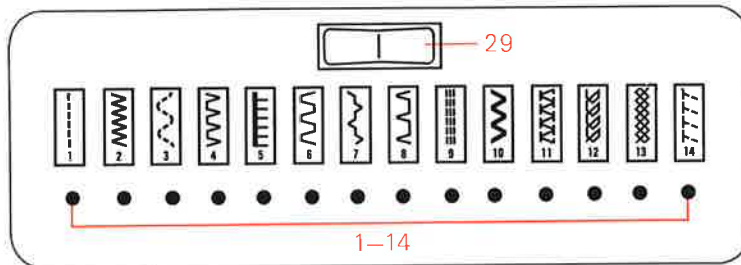

Details of the machine

- 1 Hinged front cover
- 2 Stitch plate
- 3 Presser foot
- 4 Needle clamp
- 5 Thread cutter
- 6 Thread regulator
- 7 Securing stitch control
- 8 Thread take-up lever
- 9 Pre-tension stud
- 10 Tension regulating dial
- 11 Bobbin winder (with on/off switch)
- 12 Thread holder pins
- 13 Needle position buttons and indicators
- 14 Stitch width knob
- 15 Handwheel
- 16 Stitch width knob length
- 17 Power switch
- 18 Feed-dog knob
- 19 Connection for foot control unit
- 20 Quick needle threader
- 21 Mains cable
- 22 Socket for Free Hand System (FHS)
- 23 Selector buttons for general functions
- 24 Carrying handle
- 25 Presser foot indicator
- 26 Practical stitches (selector buttons and indicators) 1-14
- 27 Decorative stitches (selector buttons and indicators) 15-28
- 28 Sewing light switch (rear of machine)
- 29 Presser foot lifting lever
- 30 Toggle switch



IMPORTANT SAFETY INSTRUCTIONS

When using an electrical appliance, basic safety precautions should always be followed, including the following:

Read all instructions before using this sewing machine.

DANGER

To reduce the risk of electric shock:

1. An Appliance should never be left unattended when plugged in.
2. Always unplug this appliance from the electric outlet immediately after using and before cleaning.
3. Always unplug before relamping. Replace bulb with same type rated 6 Volts / 4 Watts.

WARNING

To reduce the risk of burns, fire, electric shock or injury to persons:

1. Do not allow to be used as a toy. Close attention is necessary when this appliance is used by or near children.
2. Use this appliance only for its intended use as described in this manual. Use only attachments recommended by the manufacturer as contained in this manual.
3. Never operate this appliance if it has a damaged cord or plug,

if it is not working properly, if it has been dropped or damaged, or dropped into water. Return the appliance to the nearest authorized dealer or service center for examination, repair, electrical or mechanical adjustment.

4. Never operate the appliance with any air openings blocked. Keep ventilation openings of the sewing machine and foot controller free from accumulation of lint, dust and loose cloth.
5. Keep fingers away from all moving parts. Special care is required around the sewing machine needle.
6. Always use the proper needle plate. The wrong plate can cause the needle to break.
7. Do not use bent needles.
8. Do not pull or push fabric while stitching. It may deflect the needle causing it to break.
9. Switch the sewing machine off when making any adjustments in the needle area, such as threading needle, changing needle, threading bobbin, or changing presser foot, and the like.
10. Always unplug sewing machine from the electrical outlet when removing covers, lubricating or when making any other user servicing adjustments mentioned in the instruction manual.

11. Never drop or insert any object into any opening.
12. Do not use outdoors.
13. Do not operate where aerosol (spray) products are being used or where oxygen is being administered.
14. To disconnect, turn all controls to the off position, then remove plug from outlet.
15. Do not unplug by pulling on cord. To unplug, grasp the plug, not the cord.
16. Appliances provided with a cord reel: Hold plug when rewinding into cord reel. Do not allow plug to whip when rewinding.
17. This appliance is provided with double insulation. Use only identical replacement parts. See instructions for Servicing of Double-Insulated Appliances.

Servicing of Double-Insulated Products

In a double-insulated product, two systems of insulation are provided instead of grounding. No grounding means is provided on a double-insulated product, nor should a means for grounding be added to the product. Servicing of a double-insulated product requires extreme care and knowledge of the system, and should be done only by qualified service personnel. Replacement parts for a double-insulated product must be identical to those parts in the product. A double-insulated product is marked with the words «DOUBLE INSULATION» or «DOUBLE INSULATED».

The symbol may also be marked on the product.

SAVE THESE INSTRUCTIONS!



Dear Bernina Customer

Congratulations on choosing a Bernina 1090S. You are now the proud owner of a sewing machine which fulfils every expectation in terms of use and quality. You own a first class product which will give you sewing pleasure für many years to come.

Some hundred years ago, my great grandfather invented the first ever hemstitch machine. This was the beginning of the Bernina family business and I am proud to be the fourth generation member of the family to have responsibility for the company. I am delighted to welcome you to the millions of satisfied Bernina owners around the world.

If you require any further information about your sewing machine or sewing in general, please do not hesitate to contact your Bernina dealer, who will be delighted to help you.

I wish you very happy and successful sewing.

Yours truly,

Hanspeter Ueltschi
President

BERNINA®

Index

Index

A		E		J		N		
Accessories	9	Edge stitching	39	Jeans foot	22, 36	Neckband		
Accessories box	9	Edges, oversewing	28	Jersey stitch	23, 33, 46	– with decorative seam	32	
– fitting	9	Edging stitches	24			– with overlock seam	32	
– removing	9	Edging with elastic thread	46			Needle and fabric	18	
				K		Needle breaks	50	
B		F		Knitted fabrics, sewing		32	Needle positions	27
Balance	26, 30	Fault prevention	50			Needle stop	10	
Basic setting		Faulty stitching	50	L		– down	26	
– altering	29	Faulty tension	50	Leather/Plastic	36	– electronic	10	
– combining with functions	30	Feed-dog		Lifter	11	Needle, inserting	16	
– retrieve	29	– lowering the	15	– attaching	11	Needle, standard	19	
Blind hemming	38	– lower	11	– and lower the feed dog	11	Needle/Thread table	18	
Blind stitch	23	– and fabric feed	20	Long stitch	37	Needles and the sewing machine	18	
Bobbin case and bobbin	12	– and presser feet	20	Lower thread		Needles and thread	18	
Bobbin winding	12	– and sewing of corners	20	– breaks	50	Needles, all about sewing machine needles	18	
Buttonhole		– and stitch length	20	– bringing up	15	Needles, special	19	
– 3-step	40	Flat joining seam	34, 35	– winding	12	Needle threader	14	
with gimp cord	41	Floral stitches	24			– threading the needle	14	
– marking	40	Foot control unit	10					
– cutting	41	– connecting	10	M				
– automatic	42	– and electronic needle stop	10	Machine		Oiling and cleaning	52	
with gimp cord	43	Forward stitching	27	– fails to run	50	Open seams	34	
		Free Hand System (FHS)	11	– stitching in reverse	50	Overlock seams	34	
		Function buttons	26	– will only run slowly	50	Overlock stitches	23	
C		– balance	26, 30	Mains cable	10	Oversewing edges	28	
Carrying case	8	– clear button (CLR)	26	– connecting	10			
Changing the bulbs	51	– long stitch	26	Maintenance	52			
Cleaning and oiling	52	– mirror image	26	Marking buttonholes	40			
Clear button (CLR)	26	– needle stop down	26	Mending				
Clearing	26	– presser foot indicator	26	– interlock fabric	46			
Compact stitches	24	– programming button	26	– tears using Running stitch	44			
Cutter	15	MEM	26	– woven fabric	45			
		– reduced sewing speed	26	Mirror image	26			
		– reverse sewing button	26	Motor	10			
D		– securing stitch control	27					
Darning	47	– single pattern (pattern end)	26					
– with small darning ring	48	– toggle switch	26					
Decorative stitches	24			G				
– altering the basic setting	29			Gathering stitch	23			
– combining with functions	30							
– programming	31							
Double overlock	23							
Double overlock seam	35							
		H						
		Hem, visible with						
		– Jersey stitch	33					
		– Triple zig-zag	33					
		Hems, practical stitch	33					
		Honeycomb stitch	23, 32, 43					
		Hook	52					
				I				
				Important	6, 53			
				Inserting the bobbin	13			
				Interlock fabric mending	46			

Index

P

Patching using
 – Honeycomb stitch 45
 – Jersey stitch 46
 Pattern end (single pattern) 26, 30
 Pearl stitches 24
 Plastic/Leather 36
 Power switch 10
 Practical stitch hems 33
 Practical stitch seams 34, 35
 Practical stitches
 – forward sewing 23
 – reverse sewing 23
 – table 23
 Presser feet 22
 – blind stitch foot 22, 39
 – buttonhole foot 22, 40, 41
 – buttonhole foot with slide 22, 42
 – changing 16
 – darning foot 22, 47
 – embroidery foot 22
 – jeans foot 22, 36
 – overlock foot 22, 35
 – reverse pattern foot 22
 – zip foot 22, 36
 Presser foot indicator 26
 Prevention, fault 50
 Programming 26, 31
 Programming button (MEM) 26
 Publications 53

R

Reducing sewing speed 26, 31
 Reverse sewing 27
 Reverse sewing
 – button 26, 30
 Running stitch 23, 44

S

Safety instructions 1
 Satin stitch 28
 Seams
 – double overlock seam 35
 – flat joining seam 34, 35
 – open seams 34
 – overlock seams 34
 – stretch seams 34
 – stretch overlock seam 35
 – triple straight stitch seam 34
 – vari-overlock seam 35
 – zig-zag seam 34

Securing stitch control 27
 Sewing light 10
 – changing bulbs 51
 Sewing machine needles, all about 18/19
 Sewing speed, reduced 26, 31
 Sewing table 11
 – fitting 11
 – removing 11
 Sewing thick fabrics 36
 Single pattern (pattern end) 26, 30
 Special needles 19
 Stitch length, to alter 27
 Stitch width, to alter 28
 Stitches
 – decorative stitches 24
 – edging stitches 24
 – compact stitches 24
 – floral stitches 24
 – pearl stitches 24
 – altering the basic setting 29
 – combining with functions 30
 – faulty stitching 50
 – forward sewing practical stitches 23
 – Blind stitch 23, 38
 – Gathering stitch 23
 – Running stitch 23, 42
 – Straight stitch 23, 27
 – Stretch stitch 23, 34
 – Universal stitch 23
 – Vari-Overlock 23, 32, 35
 – Zig-zag stitch 23, 28
 – reverse sewing practical stitches 23
 – Double overlock 23, 35
 – Honeycomb stitch 23, 32, 45
 – Jersey stitch 23, 33, 46
 – Stretch Overlock 23, 35
 – Triple straight stitch 23, 34
 – Triple zig-zag 23, 33
 Stitching
 – edge 39
 – forward 27
 – needle positions 27
 – reverse sewing 27
 – top 37, 39
 Straight stitch 23, 27
 – triple straight stitch 23, 34
 Stretch Overlock 23, 35
 Stretch seam 34
 Stretch stitch 23, 34

T

Thread
 – bringing up the lower thread 15
 – cutter 15
 – needles 18
 – threading the upper thread 14
 Thread tension 15
 Thread, lower
 – breaks 50
 – bringing up 15
 winding 12
 Thread, upper
 – breaks 50
 – threading the 14
 Threader (Quick needle threader) 14
 Toggle switch 26, 27, 28, 29
 Top stitching 37, 39
 – using buttonhole thread (Cordonnet) 37
 Triple straight stitch 23
 Triple straight stitch seam 34
 Triple zig-zag 33

U

Universal stitch 23
 Upper thread
 – breaks 50
 – threading the 14

V

Vari-Overlock 23, 32, 35
 Vari-Overlock seam 35
 Visible hem with
 – Jersey stitch 33
 – Triple zig-zag 33

W

Woven fabric, mending 44, 45

Z

Zig-zag seam 34
 Zig-zag stitch 23, 28
 – triple 23, 33
 Zips 36

WARNING:

Before using your sewing machine, please read the Safety Instructions.

The right to make constructional changes differing from text and illustrations reserved.

Index 3

Setting up the
sewing machine 7

Threads 17
Needles

Presser feet 21
Practical stitches
Decorative stitches

Practical
sewing 25

Trouble-shooting 49
Maintenance

Setting up the sewing machine

Carry case	8
Accessories box	9
Mains cable	
Foot control unit	
Sewing light	
Power switch	
Needle stop	10
Free Hand System (FHS)	
Sewing table	11
Bobbin case and bobbin	
Winding the lower thread	12
Inserting the bobbin	13
Threading the upper thread	
Quick needle threader	14
Bringing up the lower thread	
Thread tension	
Feed-dog	15
Inserting the needle	
Changing presser feet	16

Carrying case

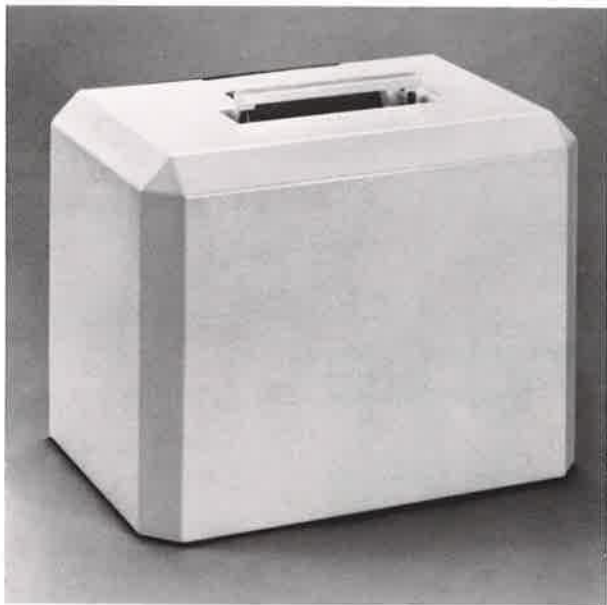

Carrying case, accessories

The carrying case protects the machine from dust and dirt.

Always carry the machine by its handle.

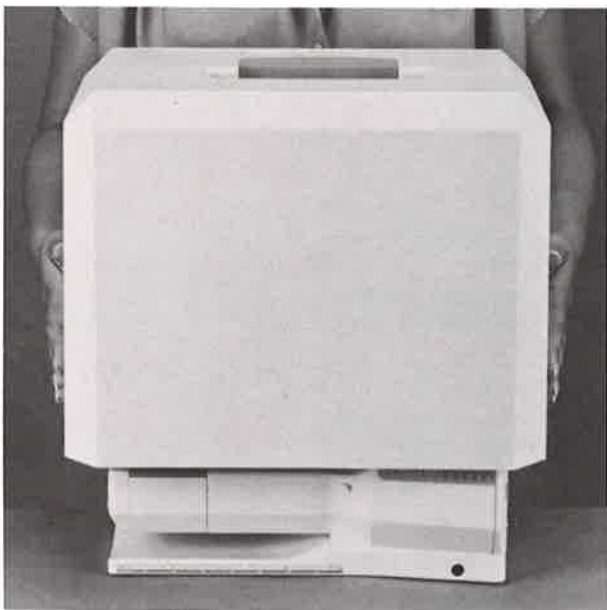

Hold the carrying case with both hands to the sides and lift it straight upwards.

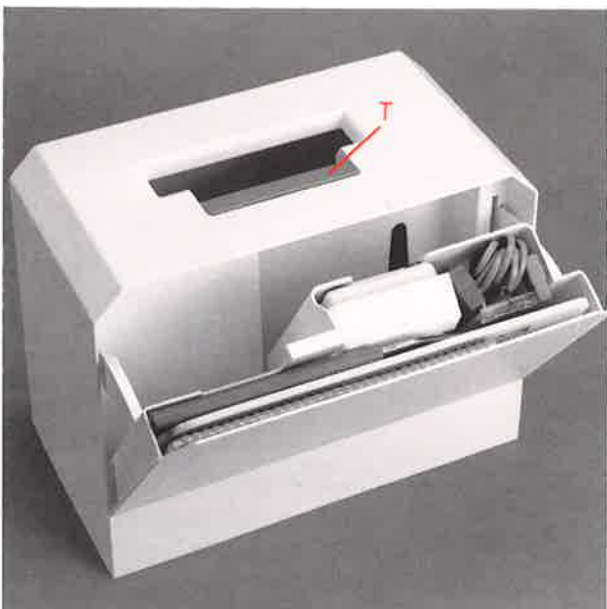

The case has a built-in accessories compartment. Press regulating bar "T" to swing out the accessories compartment. This has space to stow the foot control unit, the lifter, the sewing table and BER-NINA instruction books.

Accessories box

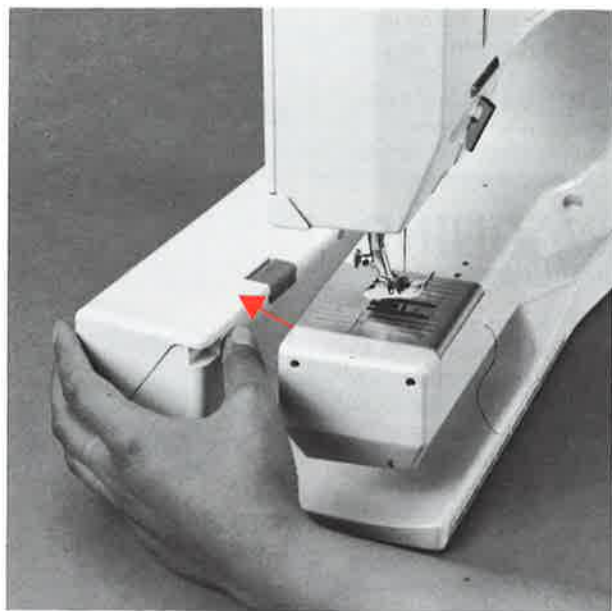

Removing the accessories box

Simply push the accessories box backwards.

Standard accessories for the BERNINA 1090 S

6 bobbins with holes
130/705 H needle assortment
Ruler-template
Seam ripper
Darning ring, with arm
Needle threader
Small screwdriver
Special screwdriver
Cleaning brush
Oiler, filled
Seam/quilting guide
Reverse pattern foot
Overlock foot
Blind stitch foot
Buttonhole foot
Zip foot
Darning foot
Jeans foot
Embroidery foot
Buttonhole foot with slide

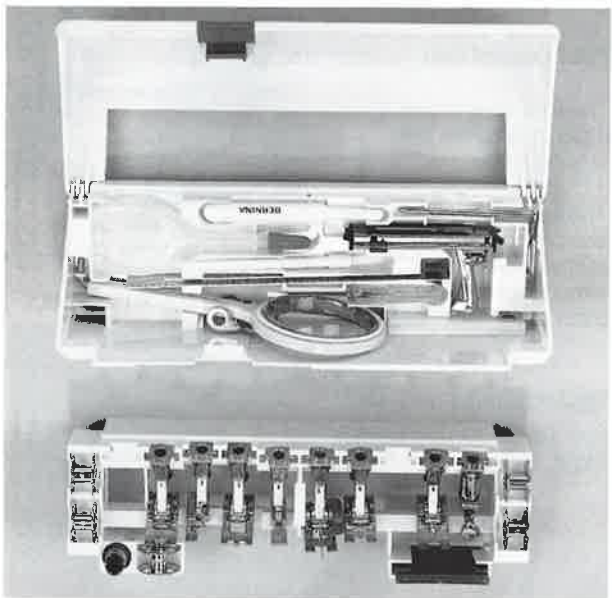

Accessories box

The accessories box allows accessories to be seen at a glance.

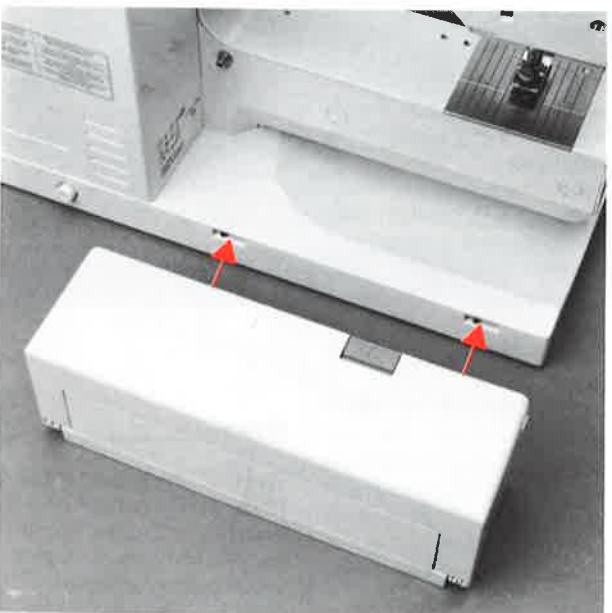

Fitting the accessories box onto the machine

The accessories box has two fixing lugs that fit into the base plate of the machine.

Lay the accessories box onto the base plate from the rear, and press against the free arm until the fixing lugs engage in the holes provided.

Mains cable, foot control unit, sewing light, power switch, needle stop

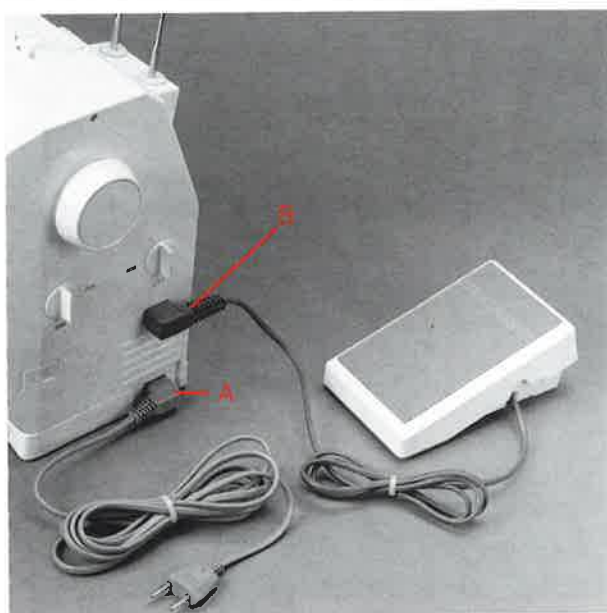

Connecting mains cable and foot control unit

Plug cable into machine socket A and mains socket. Plug foot control into machine socket B.

WARNING **(USA/Canada only)**

This sewing machine has a polarized plug (one blade wider than the other). To reduce the risk of electric shock, this plug is intended to fit in a polarized outlet only one way. If the plug does not fit fully in the outlet, reverse the plug. If it still does not fit, contact a qualified electrician to install the proper outlet. Do not modify the plug in any way.

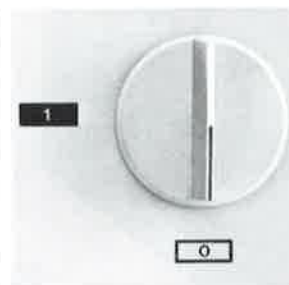

Power switch

The power switch is the rear knob on the hand-wheel side of the machine.
 0 The machine is switched off.
 1 The machine is switched on.

Electronic needle stop and foot control unit

Whenever you stop sewing, the electronic system returns the needle to its highest position. By gently tapping the back of the foot control with the heel, the needle can be moved electronically down into the work or respectively up out of the work.



Foot control unit

The foot control unit is used to regulate the sewing speed.

The sewing speed can be controlled from virtually 0 to maximum speed by varying the pressure on the plate of the foot control unit.

USA/Canada only **use only foot controller** **Type 366.**



Sewing light

The sewing light is switched on and off by means of the switch at the rear of the machine.

When the power switch is in the 0 position, the sewing light is also off.

Motor

The D.C. motor and electronic speed control give exceptionally good fabric penetration power, even when sewing at slow speed.

Free Hand System (FHS), sewing table

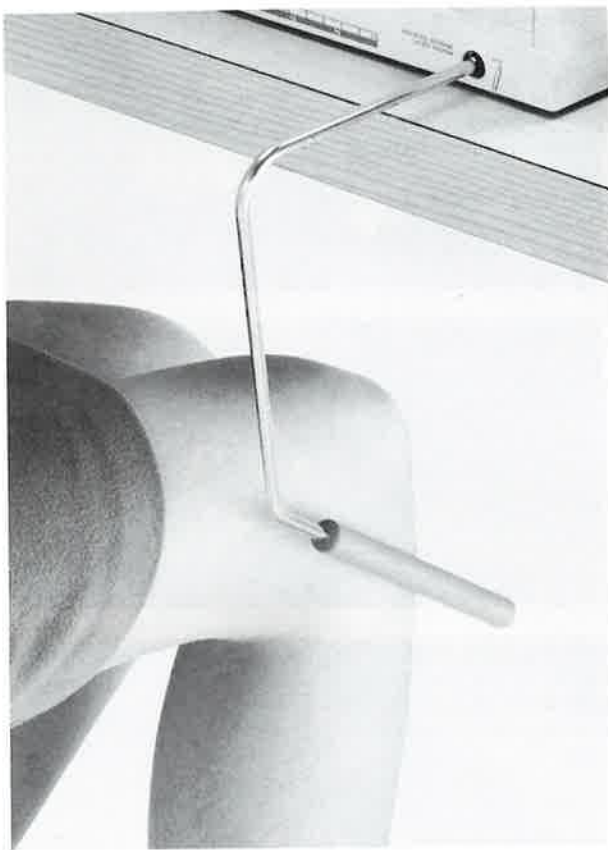

Raise the presser foot Lower the feed dog

Many sewing operations are much simpler if both hands are free to guide the work.

The Free Hand System (FHS) is operated by the right knee and is used to raise and lower the presser foot, leaving both hands free.

When the lifter is moved to the right, the presser foot is raised and at the same time the feed dog is lowered.

The next stitch returns the feed-dog to sewing position.

Attaching the lifter

The lifter socket is located on the front right hand side of the base plate. Insert the presser foot lifter so that it hangs to the left.

It should be possible to operate the lifter comfortably with the right knee, without need to alter the customary sitting position. If the angle of the lifter is uncomfortable, it can be adjusted.

Your BERNINA dealer will be pleased to make this adjustment for you.

Sewing table

The sewing table enlarges the working surface and simplifies all sewing work where the free-arm is not required.

The seam guide is pushed from the left into the groove on the underside of the table and can be adjusted over the whole width of the sewing table.

The seam guide is in addition to the small ruler provided in the accessory box and allows you to sew and guide any seam width up to 15 cm (6").

The «0» on the measurement scale represents the centre needle position.

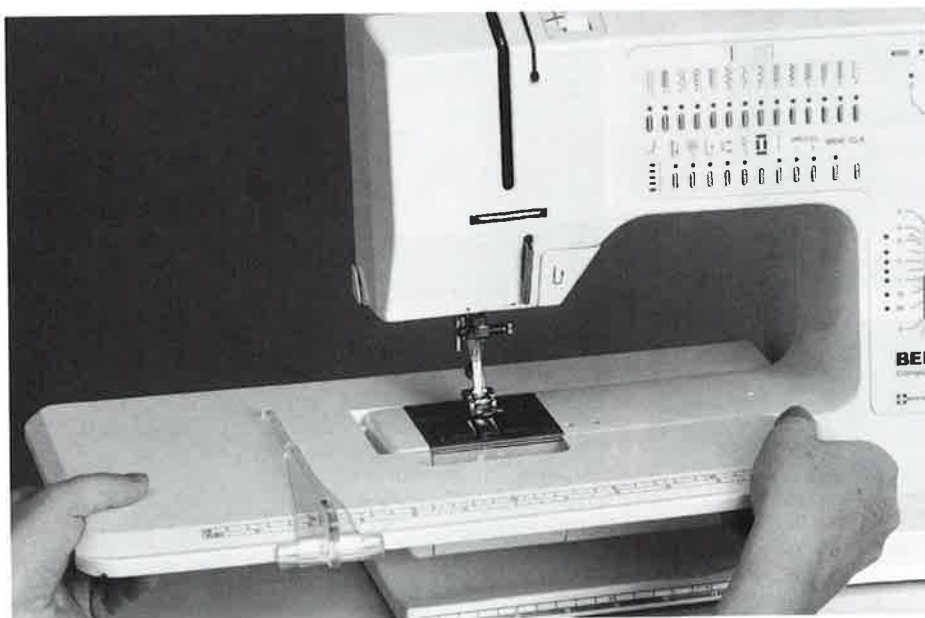

Fitting the sewing table

Slide the table along the free arm until the centering pins engage in the holes provided. Press firmly from the left to lock the sewing table in position on the machine.

Removing the sewing table

Push firmly to the left (away from the machine) to release the sewing table.

Bobbin case and bobbin, winding lower thread

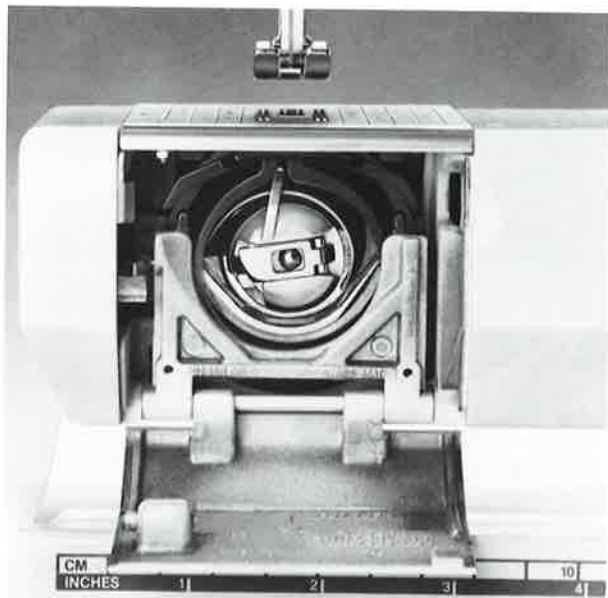

▲1

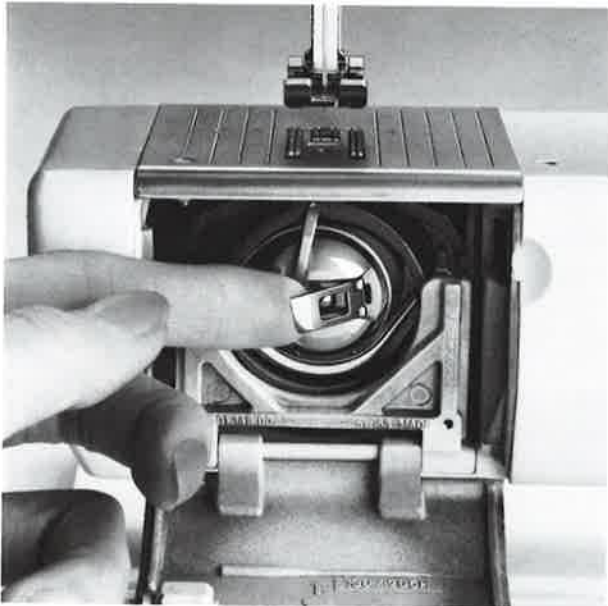

▲2

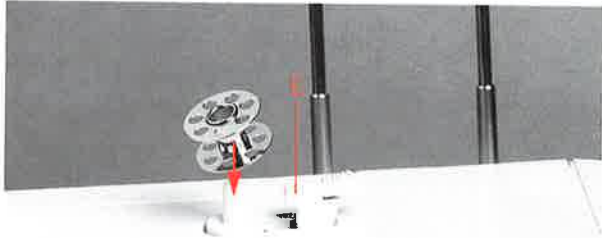

▲3

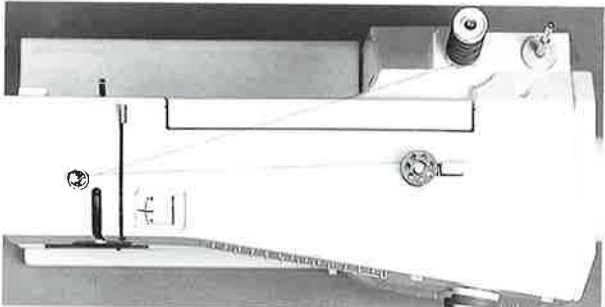

▼4

Removing the bobbin case

Set the power switch to the **0** position. Check that the needle is raised. If not, raise the needle with the handwheel. Open the hinged front cover on the free arm (fig. 1).

With the index finger of the left hand, pull the bobbin case latch forward (fig. 2) and remove the bobbin case.

Winding lower thread

Place empty bobbin on spindle (fig. 3). Take thread from the cotton reel on the thread holder pin, pass thread clockwise around the pre-tension stud to the empty bobbin (fig. 4). Wind around the empty bobbin several times, again in a clockwise direction. Set the power switch to the **1** position. Press the engaging lever E against the bobbin.

Start the bobbin winder motor with the foot control. The speed of the bobbin winder can be regulated by increasing or decreasing the pressure on the foot control.

WARNING:

Please refer to the safety instructions.



▲5

When removing the bobbin, cut the thread by pulling it under and up against the thread cutter at the base of the spindle (fig. 5).

Inserting the bobbin

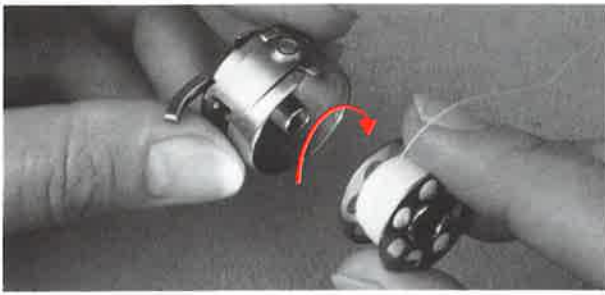

Inserting the bobbin

Hold the bobbin case in the left hand. Insert the bobbin with the thread running in a clockwise direction, see arrow.

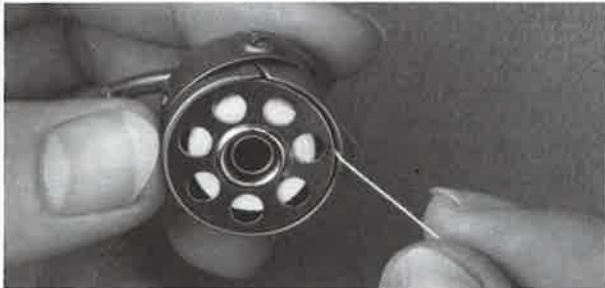

Bring thread anticlockwise to the slot.



Pull the thread into the slot and

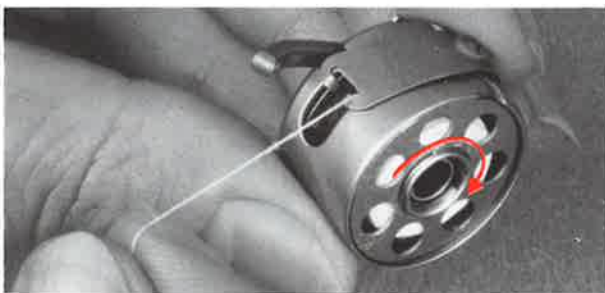

under the spring until it lies in the T-shaped slot at the end of the spring. When the end of the thread is pulled, the bobbin should turn clockwise, in the direction of the arrow.

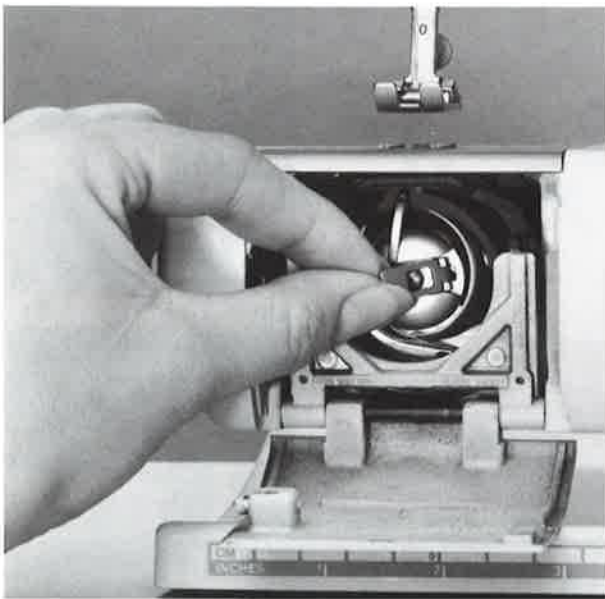

Inserting the bobbin case into the hook

Hold the bobbin case by the latch with the index finger and thumb of the left hand. Insert so that the finger of the bobbin case points upwards, engaging in the notch of the hook race cover. Check: pull end of thread. Close the hinged front cover.

Threading the upper thread

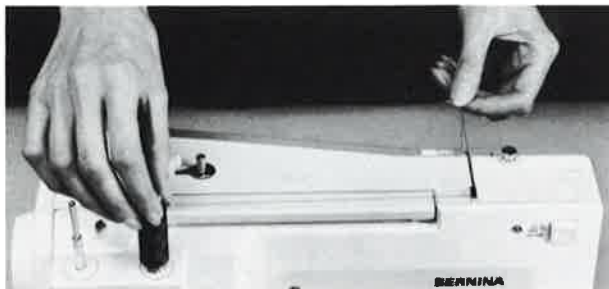

▲1

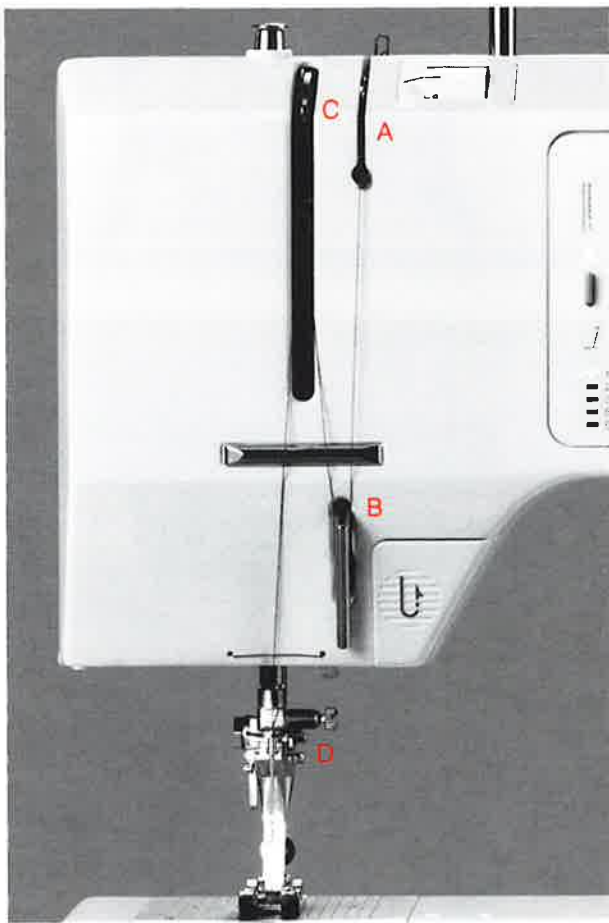

▲2

WARNING:

Please refer to the safety instructions.

Threading the upper thread

Set the power switch to 0 .

Check that the needle is in the raised position. Raise the presser foot. Place the cotton reel on one of the two thread holder pins. Hold the cotton reel in position whilst threading.

First clip the thread into the thread guide on the top of the machine, then bring it through the long slot (A) of the thread tension (fig. 1).

At the front of the machine, take the thread downwards under the thread regulator (B), up again to the thread take-up lever at the top (C) and then downwards to the needle holder thread guide (D) (fig. 2).

Always thread the needle from front to back.

The small white plate on the front of the presser foot shaft helps when threading the eye of the needle. Pull the thread approximately 10 cm (4") through the eye of the needle.

Quick needle threader

The Quick needle threader for threading the needle

The needle threader is positioned on the right of the machine, under the hand-wheel.

a) Lay the sewing thread lightly across the threader.

b) Position the threader to the top of the needle, press very gently and run the threader down the needle.

c) When it reaches the needle eye the threader will pass the thread through the eye of the needle. Carefully remove the needle threader.



▲a)

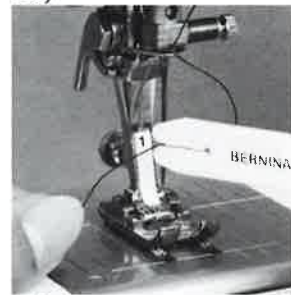

▲b)

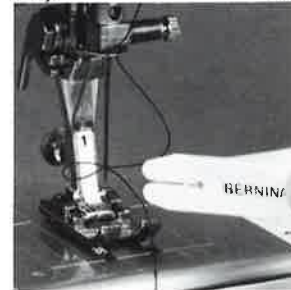

▼c)

Bringing up the lower thread, thread tension, feed-dog



▲ 1

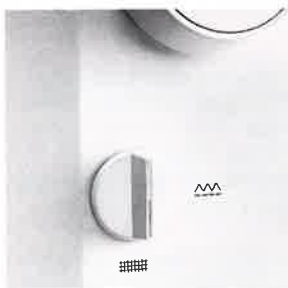

▲ 2

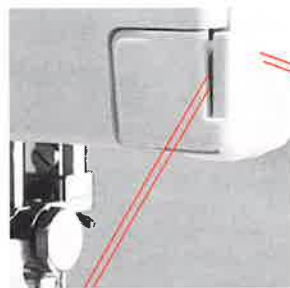

▲ 3



▼ 5

▲ 4

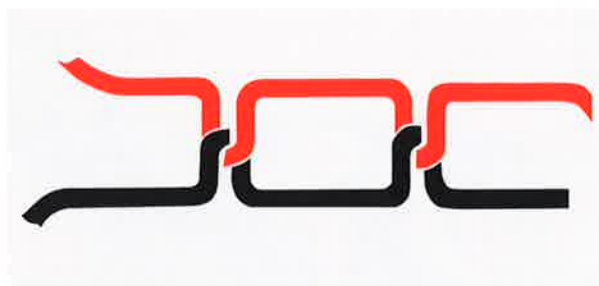

▼ 6

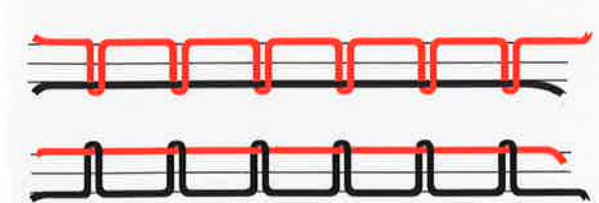



▲ 7

Bringing up the lower thread

Turn the power switch to **1**.
Hold the end of the upper thread and sew a stitch by tapping the foot control once. Pull the upper thread to bring the lower thread up through the stitch plate hole (fig. 1). Take both threads through the slot in the presser foot and to the side of the foot.

Instead of tapping the foot control, the lower thread can be brought up by turning the handwheel forwards until the needle is in its highest position.

Lowering the feed-dog

For certain types of sewing, e.g. darning, the fabric must not be moved by the feed-dog.
To lower the feed-dog, turn the knob on the handwheel side of the machine to the right until it points to the symbol  (fig. 2).
For normal sewing, the knob should face the symbol .

Thread cutter

To remove your work, raise the presser foot, take the work out to the rear left and hook both threads into the cutter. The threads ends remain secure until sewing is continued (fig. 3).

Thread tension

One of the main advantages of BERNINA machines is that there is very rarely any need to alter the thread tension for normal sewing. For the normal tension setting, the red mark on the tension regulating dial should match the adjacent mark on the machine (fig. 4). For special sewing, the thread tension can be adjusted with the aid of the regulating dial. Turning the tension regulating dial forwards, to number 4 or below, gives a looser upper thread tension. Turning the tension regulating dial backwards, to number 6 or above, gives a tighter upper thread tension. When the tension is **correctly** set, the upper and lower threads form loops between the two layers of fabric (fig. 5). **Incorrect** upper thread tension will produce knots, loose loops or thread breakage. If tension is too loose knots will form on the underside (fig. 6). If tension is too tight knots will form on the upperside (fig. 7).

Important!

The thread tension should be reset to normal when the special sewing has been completed.

Inserting the needle, changing presser feet

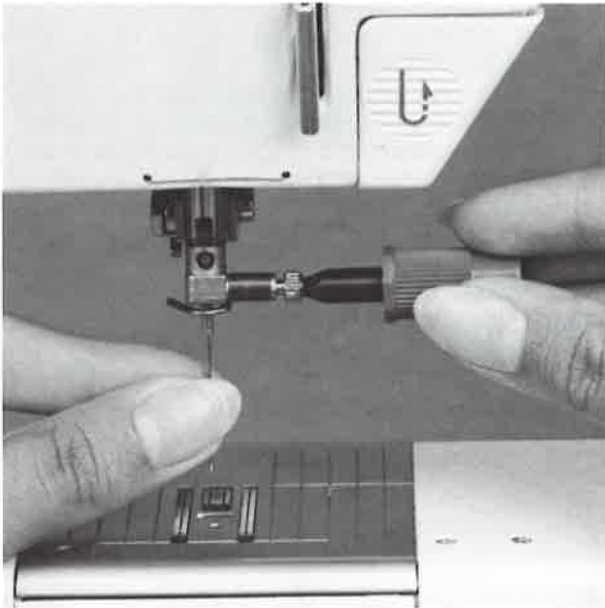

Inserting the needle

A small brown screwdriver for slackening or tightening the needle clamp is provided in the accessories box.

Set the power switch to the  position. Check that the needle is in the raised position. Lower the presser foot.

To slacken the needle clamp: Half a turn forwards, anticlockwise (fig. 1).

To insert the needle: The flat side of the needle shank should always be to the rear. Insert the needle until it reaches the top. If the needle does not reach the top, ie. is set too low, faulty stitches will result. Tighten the needle clamp securely.

WARNING:

Please refer to the safety instructions.

▲1

Changing presser feet

For the various presser feet and their uses, see page 22.

The success of a piece of sewing is largely governed by the correct choice of the presser foot. The feet are therefore easy and practical to change.

Set power switch to the  position.

Check that the needle is in raised position.

Raise the presser foot (fig. 2).

Raise the clamping lever with the index finger of the right hand, and using the middle finger and the thumb, remove the presser foot (fig.3).

To attach the presser foot: the procedure is the same, but press the clamping lever downwards with the index finger (fig. 4).

Set the power switch to the  position.

▲2

▼3

▼4

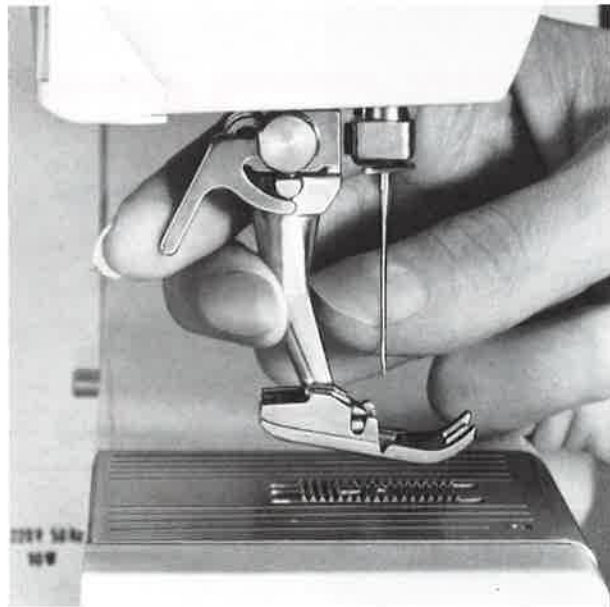
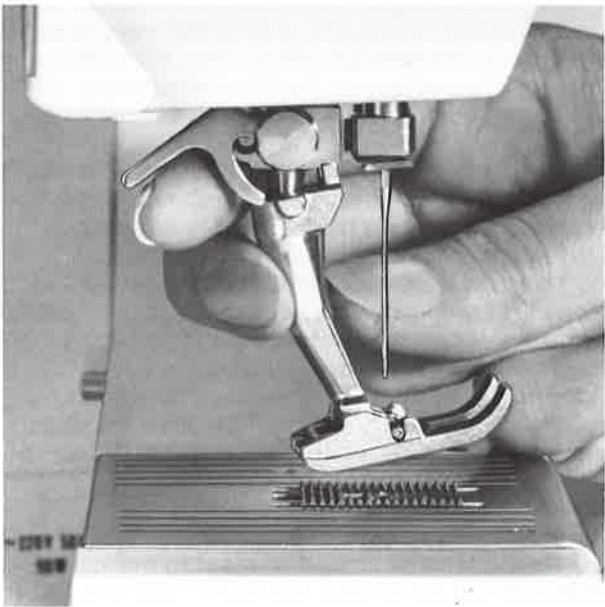

Threads Needles

Needles and the sewing machine	
Needles and thread	
Needle and fabric	
Needle/Thread Table	18
Special needles	19
Feed-dog and stitch length	
Feed-dog and fabric feed	
Feed-dog and the sewing of corners	20

All about sewing machine needles

1. Needles and the sewing machine

Your BERNINA has a 130/705 H needle system. Make sure, when buying new needles, that they are the 130/705 H system. Commercially available needle sizes are nos. 70 to 120. The finer the needle, the lower the number. For thread, the opposite applies. The finer the thread, the higher the number.

The table below shows which needle should be used for which thread.

2. Needles and thread

The needle size required depends on the thread selected. The needle must match the thread.

When sewing, the thread lies in the long groove of the needle (fig. 1). If the needle is too fine, the thread will not fit into the groove (fig. 2) and faulty stitching will result.

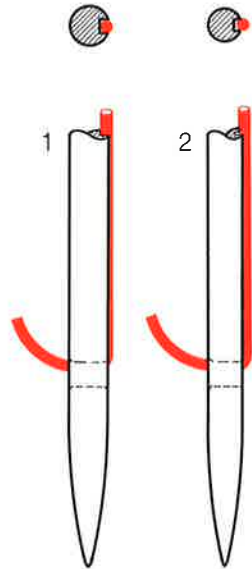

3. Needle and fabric Needle condition

The needle must be in perfect condition.

Sewing problems are caused by:

- Bent needles (A)
- Blunt needles (B)
- Hooked tips (C)

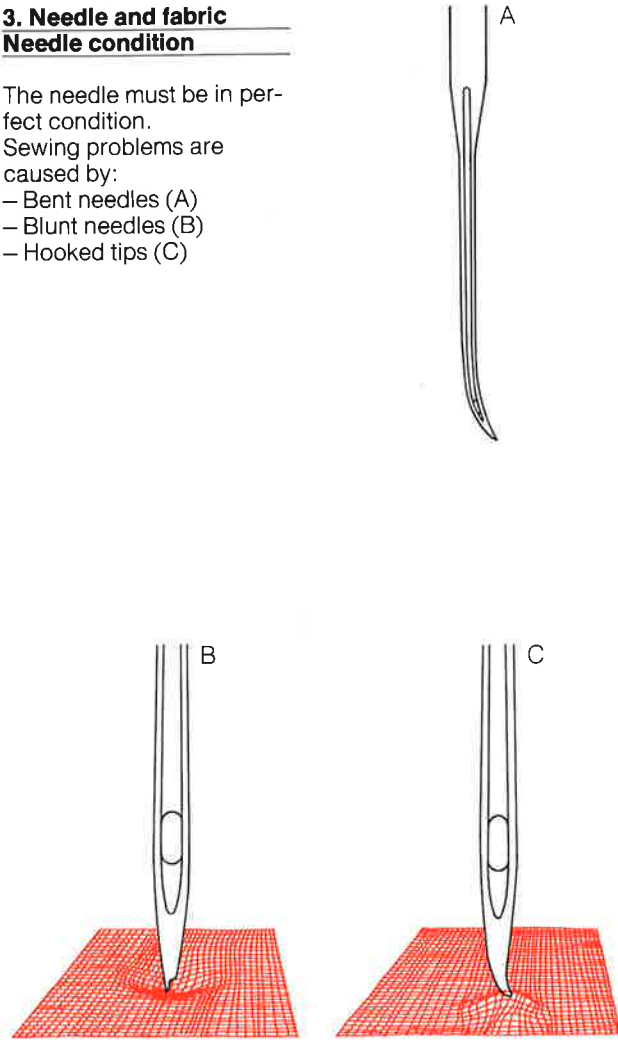



Needle/Thread Table

Needle	70	80	90	100	110-120
Darning thread	*	*			
Embroidery thread no. 30		*			
Sewing thread Mercerised cotton		*	*		
Synthetic sewing thread		*	*		
Coarse mercerised cotton Mercerised synthetic			*	*	
Buttonhole thread for top stitching (Cordonnet)				*	*

All about sewing machine needles

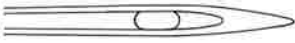
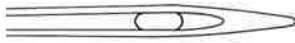
The modern domestic sewing machine is capable of handling a very wide range of fabrics. However, as in the trade, special needles are required for some of these fabrics, e.g. needles with varying types of points.

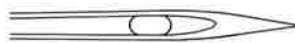
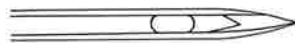
Table of special needles	Needle description	Needle point	Suitable for
Standard needle	130/705 H	Normal point, slightly rounded 	Universal needle for woven synthetic and natural fibres, e.g. linen, chiffon, batiste, organdy, wool, velvet
Special needles	130/705-SES	Fine ball point 	Fine knitted fabrics, made from silk, synthetics, cotton and fine wool
	130/705/H-SUK	Medium ball point 	Heavier knitted fabrics in synthetic or natural fibres
	130/705 H-S	Medium ball point 	Special stretch needle. Especially for delicate or difficult stretch fabrics
	130/705 H-J	Extra fine point 	Workwear, heavy linen, denim fabrics, canvas. Pierces dense fabrics more easily
	130/705 H-LR + H-LL	Cutting point 	Leather, suede, calfskin, kid pigskin, imitation leathers and suedes, plastics

Fabric feed and height compensation

1. Fabric feed and stitch length

With each stitch the feed-dog moves forward by one step. The length of this step is governed by the stitch length selected. With an extremely short stitch length, the steps are also short. The fabric moves under the foot quite slowly, even at full sewing speed. Button-holes, satin stitch and decorative stitches are all sewn with a short stitch length.

Important:

- a) Make sure that the fabric feeds evenly.



- b) Pushing will result in gaps.

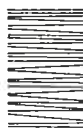

- c) Holding back will result in pile-ups.



2. Fabric feed and height compensation

The height compensating plates guarantee perfect fabric feed when sewing thick areas and topstitching edges. One, two or three compensating plates can be used depending on the thickness (height).

- a) The feed-dog can only work properly when the presser foot is flat.

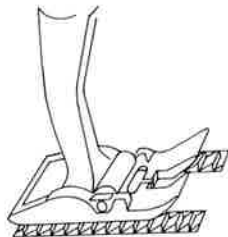

- b) When sewing thick areas, the presser foot is forced upwards which does not allow the feed-dog to grip and feed the fabric correctly.

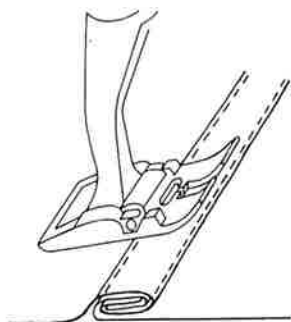

- c) To compensate for the height (thickness), place one, two or three compensating plates behind the needle under the presser foot.

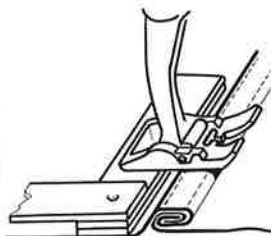

- d) To compensate in front of the presser foot, place one or more plates to the right of the foot flush with the needle. Sew over the thick area and then remove the plates.

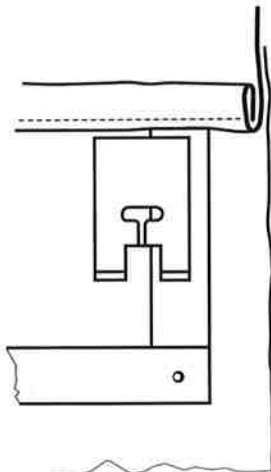

3. Fabric feed and sewing corners

- a) The two rows of teeth of the feed-dog are quite a distance apart because of the width of the zig-zag needle hole.



- b) When sewing corners, only a small part of the fabric is actually on the feed-dog so it cannot feed the work correctly.

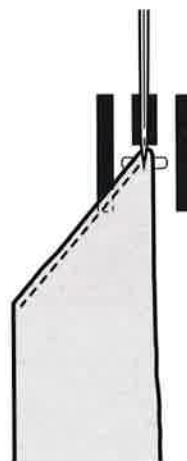

- c) For an even feed, place one or more plates to the right of the presser foot flush with the fabric edge.

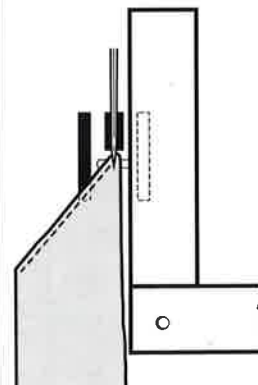

Presser feet

Practical stitches

Decorative stitches

Presser feet	22
Forward and reverse sewing practical stitches	23
Decorative stitches	24

Presser feet

Presser feet are an important aid to sewing. They are designed with grooves and guides. The success of a piece of sewing is determined by the correct choice of presser foot.

Individual presser feet are not just for one particular type of work. They can also be used to simplify other tasks.

1

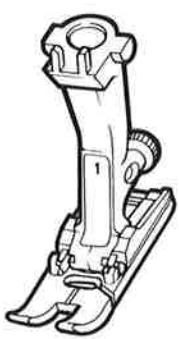

Reverse pattern foot
Practical stitches
Decorative stitches

2



Overlock foot
Vari-overlock seam
Double overlock seam
Oversewing seam edges

3

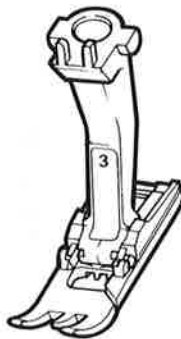

Buttonhole foot
Buttonholing

3B

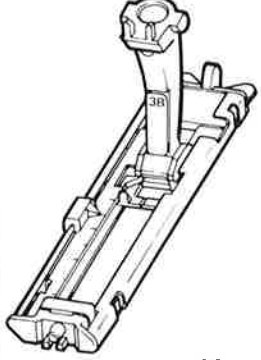

Buttonhole foot with slide
Buttonholing

4



Zip foot
sewing in zips
Piping

5

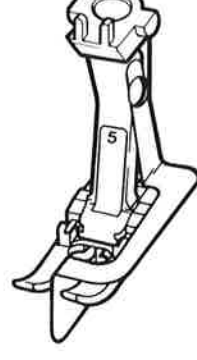

Blind stitch foot
Blind hemming
Edge stitching

6



Embroidery foot
Decorative stitching
Satin stitching
Applique
Couching

8

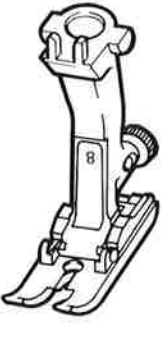

Jeans foot
Straight stitch seams in thick, hard fabrics and over thick seams

9



Darning foot
Darning
Free hand monograms
Free hand embroidery

Forward sewing practical stitches 1–8 / Reverse sewing practical stitches 9–14

1 Straight stitch



All types of non-elastic fabric.
All straight stitch work.

2 Zig-zag stitch



Most types of fabric.
All simple zig-zag work, e.g. oversewing, especially on fine fabrics, sewing on elastic and lace.

3 Running stitch



Most types of fabric.
Mending, patching, reinforcing edges etc.

4 Vari-Overlock



Primarily for fine synthetic, silk and cotton jerseys.
Elastic overlock seams and hems, particularly suitable for sports underwear, pyjamas, T-shirts, sweat-shirts, running-suits etc.

5 Stretch stitch



For highly elastic fabrics.
Highly elastic open seams for tailored outer wear, ski, horse-riding, climbing and hiking wear.

6 Universal stitch



For firmer knitted fabrics, felt, leather etc
For joining seams, visible hems, patchwork, mending on interlock, sewing on elastic, decorative seams.

7 Gathering stitch



Most types of fabric.
Gathering with cord, sewing shirring elastic, joining seams (= raw edges pressed over and butted together).

8 Blind stitch



Most types of fabric.
Blind hems, shell edging on soft jersey and fine fabrics, decorative work.

9 Triple straight stitch



For corduroy, denim, overall and deckchair fabrics, carpet borders, rucksacks, sleeping bags and similar.
Hard wearing seams for joining pieces of fabric or top stitching of seams.

10 Triple zig-zag



For denims, corduroys, leathers, decorative hems, light fabrics for blinds and similar.
Visible hems and seams, sewing on tape, extra strong seam for sportswear, woollen blankets, sleeping bags, rucksacks, deckchair fabrics etc.

11 Double overlock



Firm knitted fabrics and hand and machine knitted fabrics.
Overlock seam = Sewing and oversewing in one operation (pull-overs, jackets, sweatshirts etc.)

12 Jersey stitch



Interlock in natural, blended and synthetic fibres, velour.
Visible hems, visible seams, particularly for underwear, sweatshirts and delicate knitted fabrics, repairs in interlock underwear.

13 Honeycomb stitch



Many types of interlock and jersey fabrics.
Visible hems, visible seams for T-shirts, sweatshirts, underwear, napkins, table-cloths, craft work etc.

14 Stretch Overlock



Medium weight knitted fabrics, towelling, velour and other firm fabrics.
Overlock seams, flat joining seams, craft work.

Decorative stitches

15 Compact stitch



16 Compact stitch



17 Compact stitch



18 Compact stitch



19 Edging stitch



20 Edging stitch



21 Edging stitch



22 Pearl stitch



23 Pearl stitch



24 Pearl stitch



25 Pearl stitch



26 Floral stitch



27 Floral stitch



28 Floral stitch



Practical sewing

Function buttons	26
Straight stitch, Needle positions	27
Zig-zag, Practical stitches	28
Altering decorative stitches	29
Combining decorative stitches with functions	30
Programming decorative stitches	31
Sewing knitted fabrics	32
Practical stitch hems	33
Practical stitch seams	34, 35
Zip fastener Jeans foot Plastic/Leather	36
Long stitch	37
Blind hemming	38
Edge stitching	39
Automatic buttonhole	40
Automatic buttonhole with gimp cord	41
Automatic buttonhole with Buttonhole foot with slide	42
Automatic buttonhole with Buttonhole foot with slide with gimp cord	43
Mending woven fabric	44, 45
Mending interlock fabric	46
Darning	47
Darning with small darning ring	48

Function buttons, Use, Clearing



Presser foot indicator

This shows a suitable presser foot for the stitch selected.



Needle stop down

The machine will stop with the needle in the fabric (indication light on). When the button is pressed again the machine returns to normal, e.g. the needle is out of the fabric when the machine stops (indication light off).
Use: sewing corners, applique, outline quilting.



Reduced sewing speed

When the foot control is completely pressed down, the machine will only run at half speed (indication light on). Press the button to clear this function.
Use: for delicate work, sewing buttonholes, embroidery etc.



Reverse sewing button

The machine will sew continuously in reverse. When the button is pressed again (indicator light off), the machine will return to forward sewing.
Use: mending with the Running stitch.



Buttonhole

For sewing buttonholes see pages 40/41



Long stitch

The machine sews every second stitch.
Use: for Top stitching, edge stitching and basting in very fine fabrics.



Balance

Fine adjustment of the stitch length.
Use: satin stitch, embroidery, buttonholes etc.

CLR

Clearing

Clears function buttons and alterations to the basic setting.
EXCEPTION: these functions can only be cleared individually.

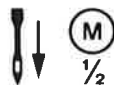

MEM

Programming

For programming the selected stitch or function.



Single pattern / pattern end

The machine will stop either at the end of a pattern or at the end of a programmed group of stitches.
Use: embroidering motifs and borders.



Mirror image

The machine will sew the selected stitch in mirror image (the indication light goes off when a new stitch is selected).
Use: sewing borders with embroidery stitches.

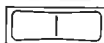

Toggle switch for selecting practical / decorative stitches

Straight stitch, needle positions

Selecting practical stitches

Press the toggle switch to the practical stitch symbols.

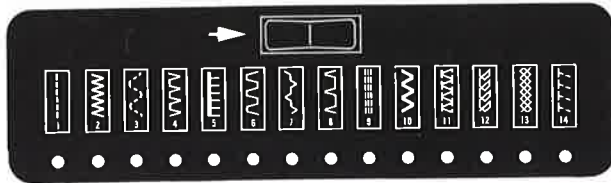

Forwards sewing

Select straight stitch. Machine sews the pre-programmed basic setting (stitch length 2).

Securing the ends

(At the beginning and end of a seam) Press the Securing stitch control and the machine will sew in reverse. After 3–4 stitches, release the Securing stitch control and the machine will sew forwards again.

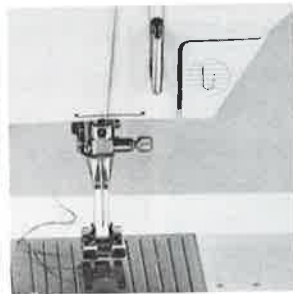

Needle positions

The position of the needle can be moved to the left or right with the aid of buttons A and B.

Typical uses:
Edge stitching, page 39.
Sewing in zips, page 36.

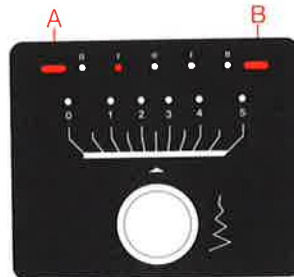

For normal seaming, the needle usually remains in the centre.

Altering the basic setting - stitch length

The control lamp shows the basic setting. The stitch length can be altered as desired by turning the stitch length dial. The indication lamp lights up to show that the basic setting is no longer valid and that the stitch length is now indicated by the bar.

Press the CLR button to return the stitch length to the basic setting (the indication lamp is extinguished).

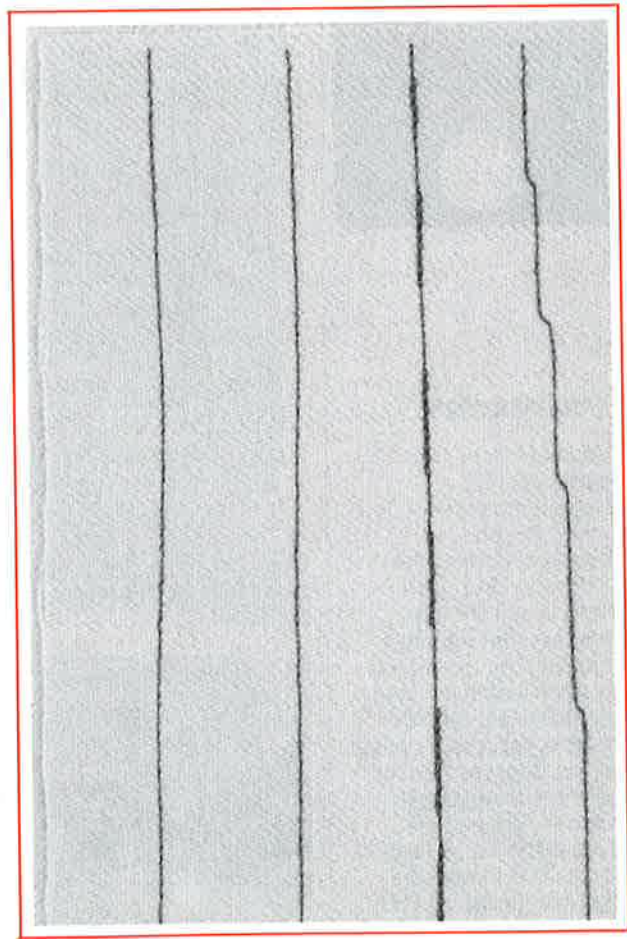

Zig-zag stitch/practical stitches

Zig-zag stitch/ practical stitches

Select zig-zag stitch or a practical stitch. The machine will automatically sew the pre-programmed basic settings for each stitch selected.

Altering the basic setting - stitch width

The control lamp shows the basic setting. The stitch width can be altered as desired by turning the stitch width dial. The indication lamp lights up to show that the basic setting is no longer valid and that the stitch width is now indicated by the bar. Press the CLR button to return the stitch width to the basic setting (the indication lamp is extinguished).



Oversewing edges

Stitch selection:
Needle: 80/70
Thread: Embroidery 60/
darning thread
If necessary adjust the
stitch width and stitch
length to suit the fabric.
Generally, the zig-zag
should not be too wide or
the stitch length too long.
Use as fine a thread as
possible, especially on fine
fabrics. Begin by cutting
away the frayed edges.
Guide the edge of the
fabric to the centre of the
foot, so that the needle
goes into the fabric, then
over the edge.

Satin stitch = close zig-zag

Select zig-zag stitch, adjust
stitch width as required.
Set stitch length to satin
stitch. Sew a test piece!



Fine adjustment with the balance buttons



If the zig-zag is too open,
press the - button once or
more times.
If the zig-zag is too close,
press the + button once or
more times.

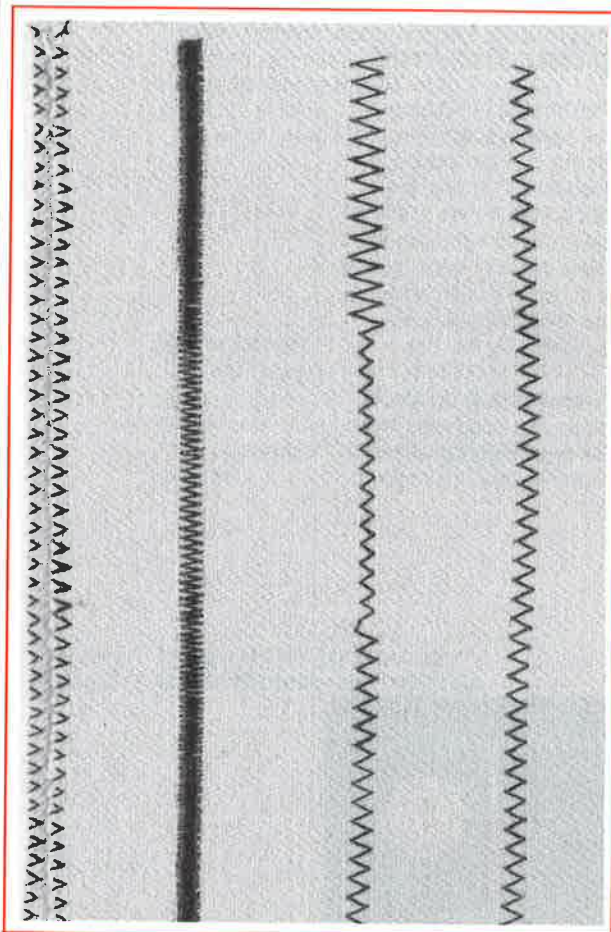
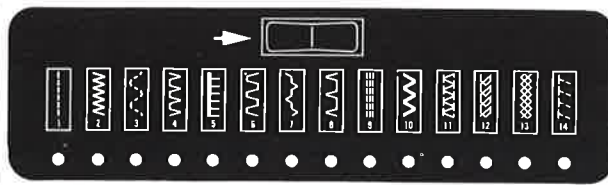

When sewing on the edge,
guide with the fingers to
the edge.



Decorative stitches, altering the basic setting

Press the toggle switch to the decorative stitch symbols.

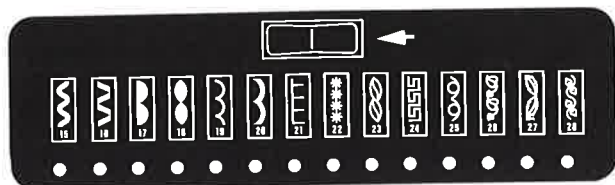

Altering the basic settings

The stitch width and length of each decorative stitch can be altered to suit any type of fabric or work. If the stitch width or length is altered, the selection control lamp lights up and the new setting is indicated by the bar. The basic setting lamps remain lit.

Returning to the basic settings

Press the CLR button to clear all altered settings.

Example

1. Select desired stitch. Basic setting control lamps lights up.
2. Adjust the stitch width to 3. Selection control lamp lights up.
3. Adjust the stitch width to $\frac{1}{2}$. Selection control lamp lights up.

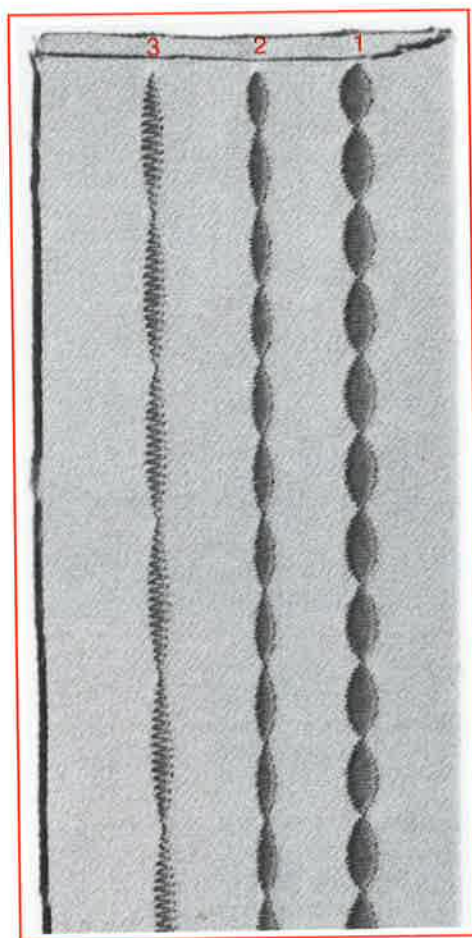





Decorative stitches, combining with functions

Combining the basic settings and functions

Combining the basic settings and function buttons can give some surprising effects.

The following function buttons can be combined with the basic settings:

-  Mirror image
-  Balance
-  Long stitch
-  Reverse sewing
-  Single pattern / pattern end

Example:

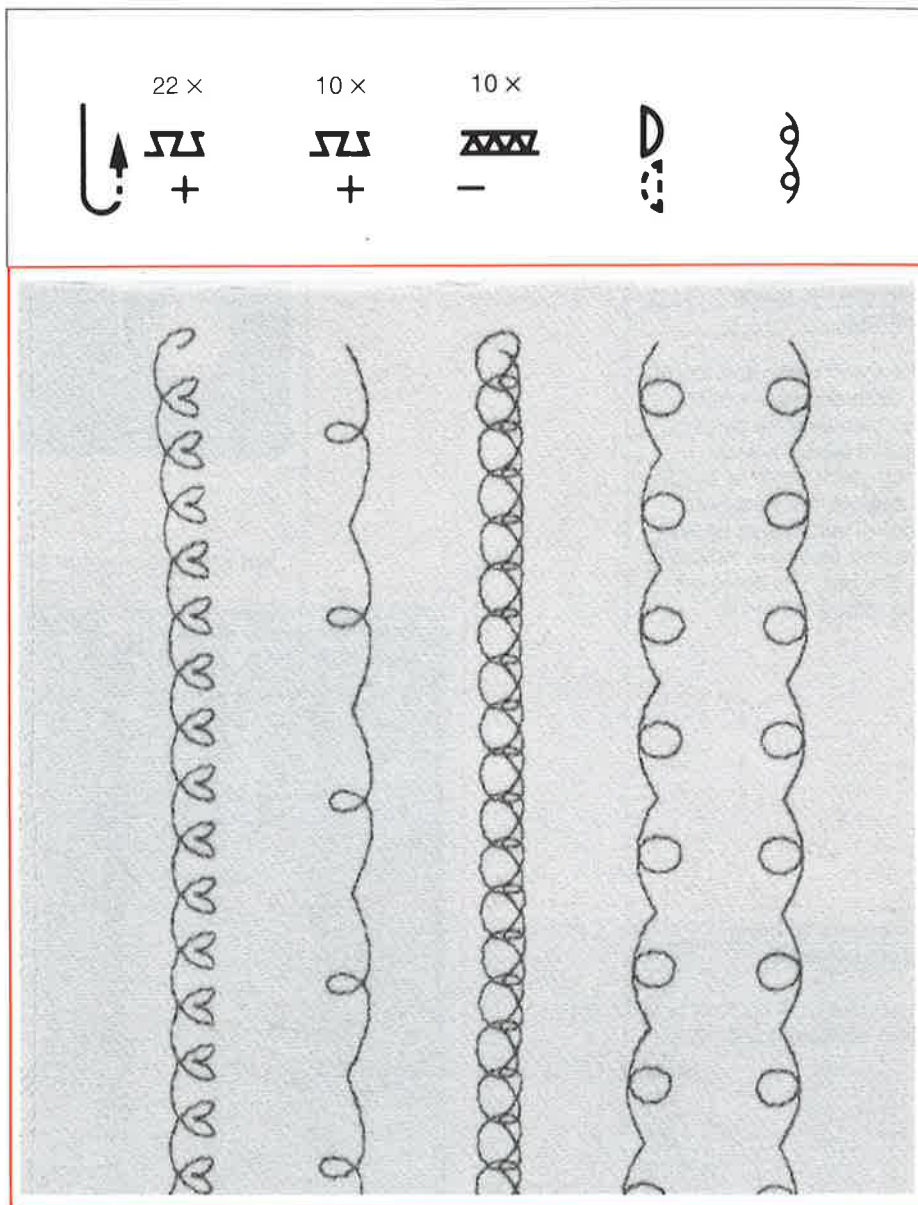

Balance

Various effects (stitch changes) result through adding numbers of Balance + or - to a stitch.

Method:

- Select the desired stitch.
- Select the desired function.

Several functions together can be added to a basic setting. Before selecting a new combination, clear the functions with the CLR button and clear special functions by pressing the individual buttons. If a button is pressed by mistake, press CLR twice.

Decorative stitches, programming

Programming enables groups of stitches to be selected and stored.

Up to five different selections can be stored.

If decorative and practical stitches are to be combined, the toggle switch must be pressed to the appropriate stitch symbols.

Method

- select desired stitch and press MEM button.
- select the next stitch and press MEM button. Continue.

Before selecting a new stitch combination, press the CLR button twice.

A useful tip for all embroidery work:

Single pattern / pattern end:



The machine will stop:
 - at the end of a stitch, or
 - at the end of a programmed group of stitches.

This function is also extremely valuable when sewing motifs or parallel rows of embroidery.

Reduced speed:



Particularly useful for tricky embroidery work.

Example 1

(sewn continuously)

- Stitch 17/ MEM 1x
- Stitch 20/ MEM 1x
- Stitch 16/ MEM 2x
- Stitch 17/ MEM 1x

Example 2

(sewn continuously)

- Stitch 25/ MEM 1x
- Select Mirror image  / MEM 1x



Example 3

(sewn in programmed groups)

- Stitch 15/ MEM 1x
- Stitch 26/ MEM 3x
- Stitch 15/ MEM 1x
- Select Single pattern /  pattern end

Example 4

(sewn in programmed groups)

- Stitch 22/ MEM 1x
- Stitch 28/ MEM 1x
- Select Mirror image  / MEM 1x
- Clear Mirror image  / MEM 1x
- Stitch 22/ MEM 1x
- Select Single pattern /  pattern end

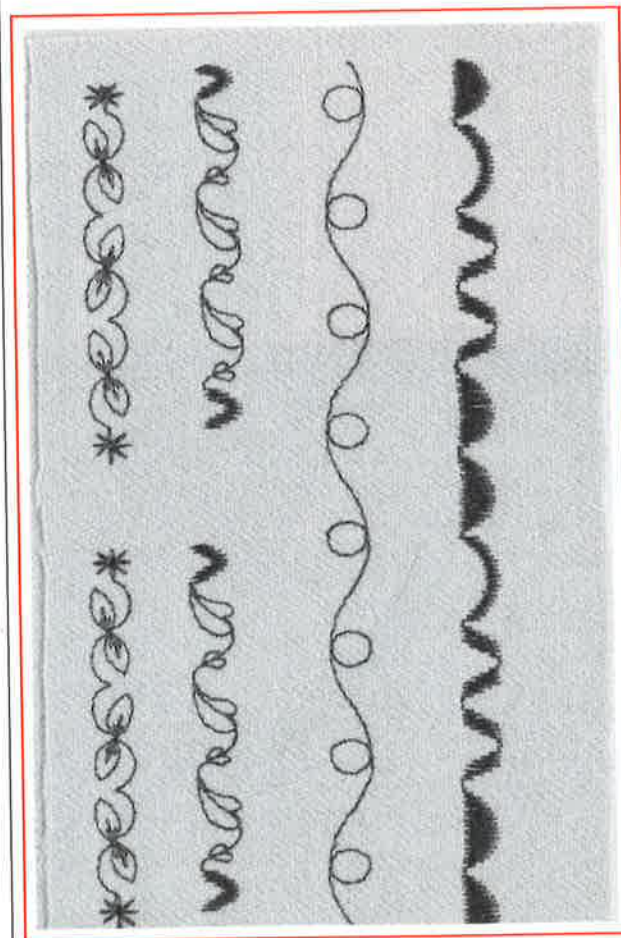

Sewing knitted fabrics

Important:

1. Use a perfect needle. Even a very slightly blunt needle will damage the knit, causing it to ladder.
2. Use fine sewing thread, particularly for fine knitted fabrics. Coarse thread can also damage the knit.
3. Use darning thread for basting. When the seam is sewn, darning thread is easier to remove than the considerably thicker and shorter fibre basting thread.
4. Press each seam as it is sewn, before going on to the next stage of sewing.

5. Sew a sample to test the stitch and stretch. As modern textiles vary considerably in their elasticity, the basic setting should be adjusted, where necessary, to suit the fabric.

For extremely stretchy fabric:
– Shorten the stitch length slightly and/or
– increase the stitch width slightly.
This gives the seam more stretch. The seam should be as stretchy as the fabric.

Neckband with decorative seam

Needle: 80
Thread: Sewing thread

● Stitch: 
Honeycomb stitch

Suitable for firmer knitted fabrics. Fold the neckband in half and press. Make sure the edges are perfectly straight. Pin and baste to the right side of the neckline. Guide the work so that the stitches come exactly to the edge of the neckband. Cut the surplus neckline fabric from behind neckband.

Neckband with overlock seam

Needle: 80/70
Thread: sewing thread

● Stitch: 
Vari-overlock

Specially designed for all fine knitted fabrics. Fold the neckband in half and press. Make sure the edges are perfectly straight. Pin and baste, right sides together, so that the edges of neckband are exactly in line with neckline edge. Position the work so that all edges are guided to the pin of the overlock foot.

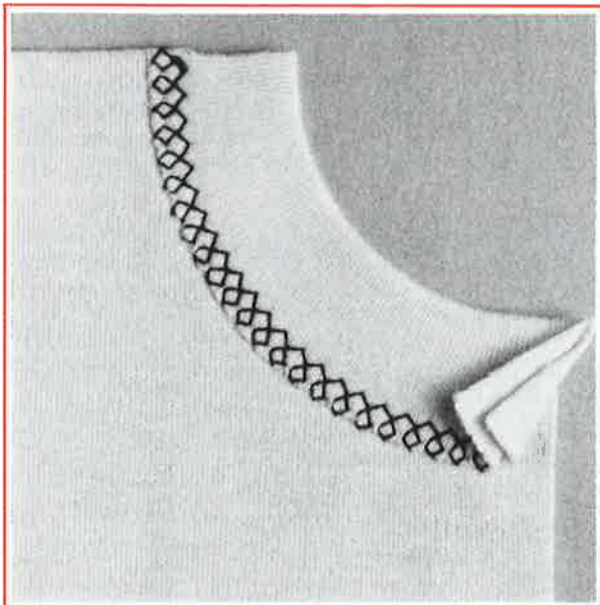

Practical stitch hems

Preparation

Baste the hem, depth of hem plus minimum of 1 cm ($\frac{3}{8}$ ") extra, sew and cut away surplus fabric against stitch. Check with instructions for working with knitted fabrics (page 32).

Visible hem with Jersey stitch

Needle: 80

Thread: Sewing thread

● Stitch:  Jersey stitch

Elastic visible hem for interlocks in cotton, fine wool, synthetic and blended fibres.

Visible hem with Triple zig-zag

Needle: 80–90

Thread: Sewing thread

● Stitch:  Triple zig-zag

Stitch width: $2\frac{1}{2}$ –5, depending on fabric

Hard wearing visible hem for firm fabrics, e.g. denim, roller blind fabric, deck-chair fabric etc.

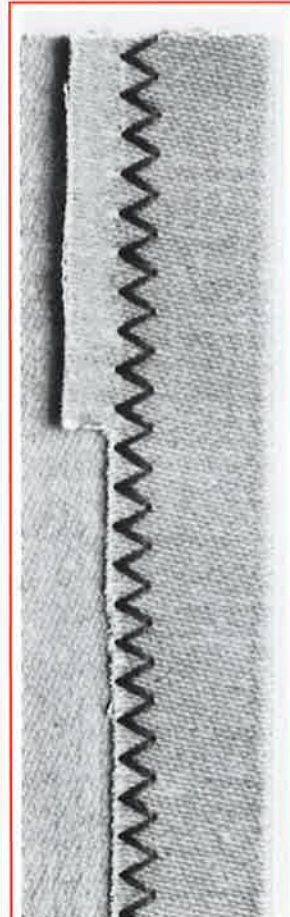

Practical stitch seams

The type of seam chosen is governed by the garment being sewn, the choice of stitch primarily by the fabric being used. There are 3 types of seams:

Open seams:

These are seams that are pressed open. They lie flat and are not bulky. They allow garments to be let out. Used in dresses, trousers, skirts, coats, jackets etc.

Overlock seams:

These are seams that are sewn and oversewn in one operation. They are quick to produce, and are narrow, but do not allow garments to be let out. Used especially for knitted fabrics on pullovers, T-shirts, sweatshirts, running suits, underwear and for hand and machine knitted garments.

Flat joining seams:

These are seams in which the edges are overlapped and then oversewn. They lie flat. They are narrow, and again cannot be let out. They do not curl. The edges are neat. Used for beachwear, leisure wear, foundation garments and craft work.

Triple straight stitch seam

Open seam

Needle: 80-90

Thread: Sewing thread

● Stitch:  Triple straight stitch

Hard-wearing reinforced seam for firm fabrics.

Zig-zag seam

Open seam

Needle: 80

Thread: Sewing thread

● Stitch:  Zig-zag stitch

Stitch width: approx. 1

Stitch length: approx. 1½

Elastic seam for interlock fabrics in wool, synthetic or blended fibres, and for silk, cotton and wool jersey.

Stretch seam

Open seam

Needle: 80

Thread: Sewing thread

● Stitch:  Stretch stitch

Highly elastic seam for stretch fabrics, especially sportswear.

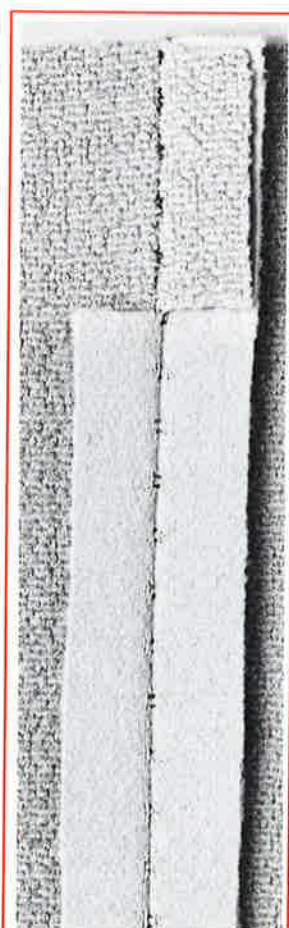
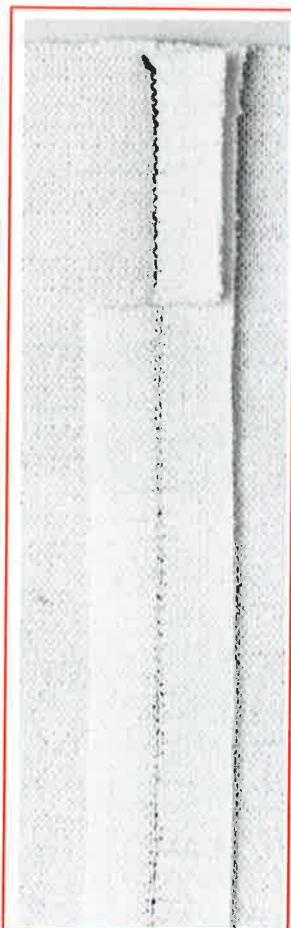

Practical stitch seams

Vari-overlock seam

Needle: 80-70

Thread: Sewing thread

● Stitch: **VVVV**
Vari-overlock

Highly elastic overlock seam for all fine jerseys: dresses, blouses, underwear, sports-underwear.

Double overlock seam

Needle: 80

Thread: Sewing thread

● Stitch: **VVVV**
Double overlock

Elastic overlock seam for firm, course or open knitted fabrics.

Stretch overlock seam

Needle: 80

Thread: Sewing thread

● Stitch: **TTTT**
Stretch overlock

Elastic overlock seam for thick, soft or looser knitted fabrics.

Flat joining seam

Needle: 80

Thread: Sewing thread

● Stitch: **TTTT**
Stretch overlock

Visible seam for towelling, velour, leather etc.

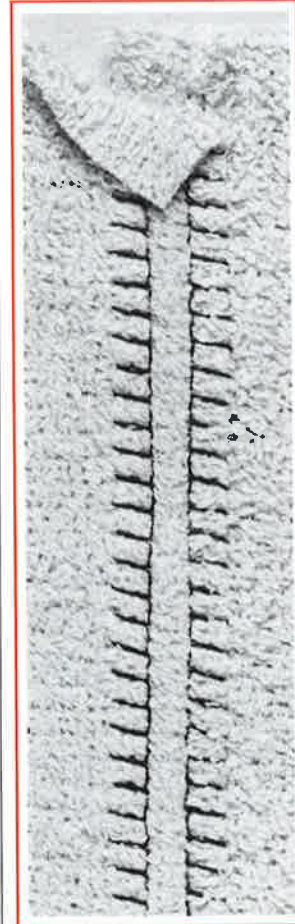
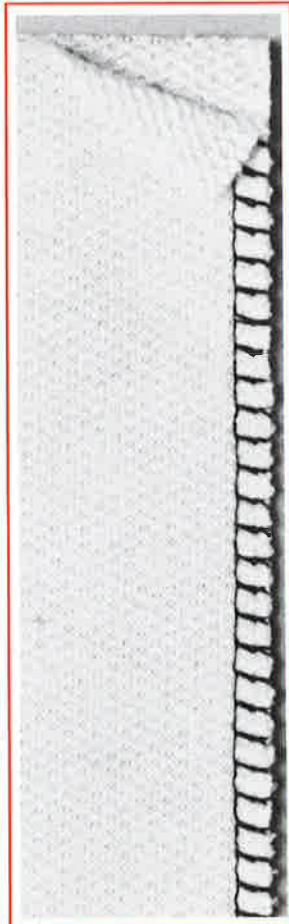
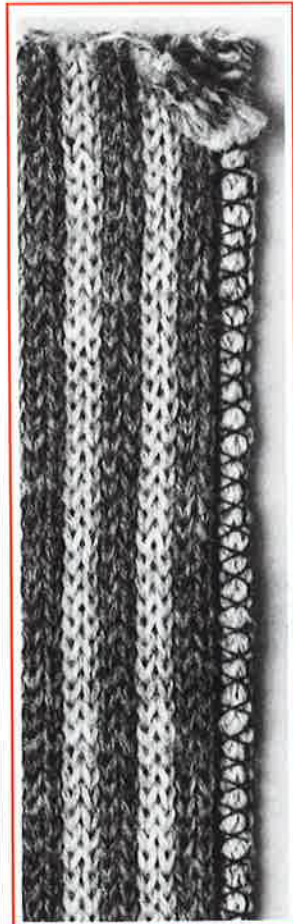
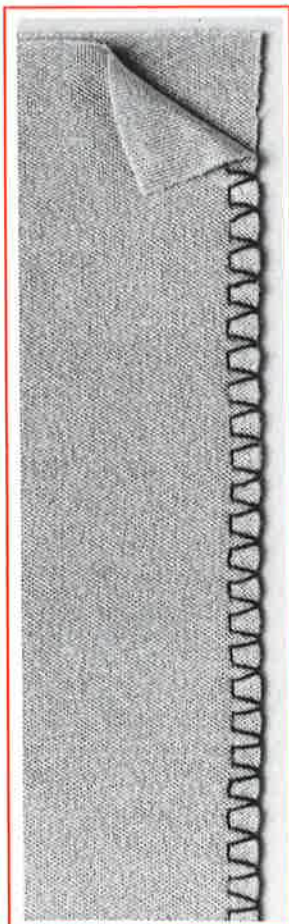

Zips

Zip fastener inserted flat

Method:

Baste entire length of seam. Mark length of zip and sew seam only to start of zip. Remove basting stitches from sewn part of seam only. Press entire seam, trim and oversew. Remove remaining basting stitches.

Baste the zip into position so that teeth are covered by the fabric.

Sew in the zip, starting each side at the bottom and sewing to the top, once with needle position right, once with needle position left.

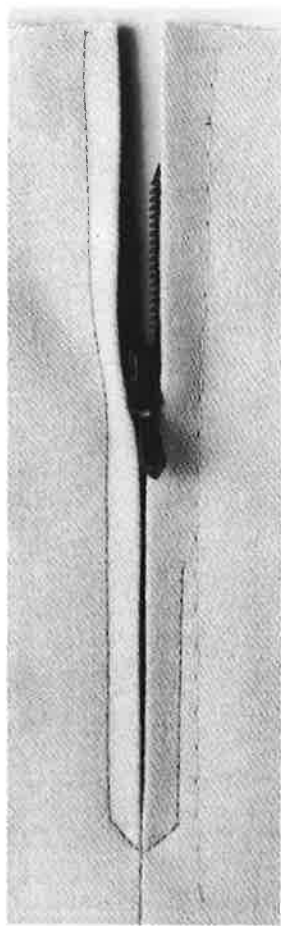

Needle: 80

Thread: Sewing thread

Zip foot: 4

● Stitch: -----

Straight stitch

Alteration:

Needle position left/right

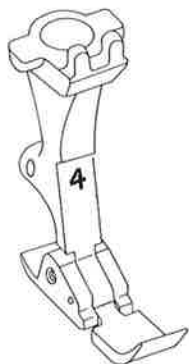

Jeans foot

Thick fabrics and seams

The Jeans foot enables exceptionally thick and hard fabrics to be sewn easily. Select a stitch length of between 2 and 3,5 mm, depending on the fabric.

Note that the needle position setting must be "centre", and the stitch width "0".

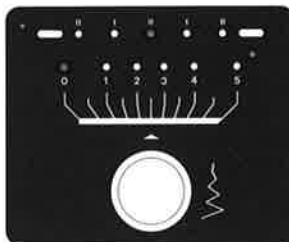

Use a Jeans needle or needle size 100.

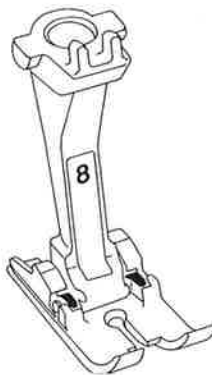

Plastic/Leather

Plastic

Like synthetic fabrics, plastic is also made from a varying number of raw materials. When sewn, plastic should be handled according to the surface and grain. If the fabric does not feed correctly, i.e. sticks to the presser foot, use one of the following special presser feet: Walking foot (No. 50), Roller foot (No. 51), Teflon foot (No. 52). Always sew plastic with a long stitch length to avoid tearing.

Leather and imitation leather

Naturally it is possible to sew leather. Some leathers will require a special leather needle. Always sew a test piece before starting on the work itself. The stitch length should not be too short. Use Walking foot (No.50), or Roller foot (No.51), or Teflon foot (No.52) as required. (These presser feet are additional accessories).

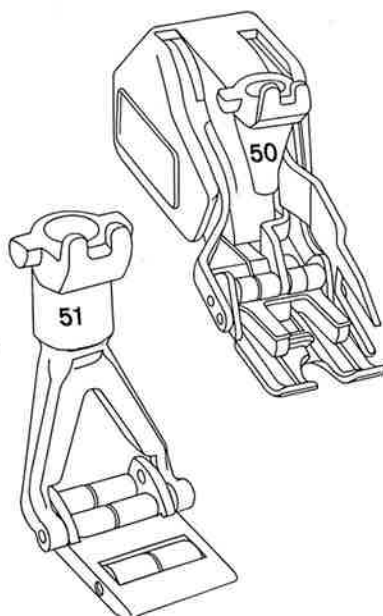
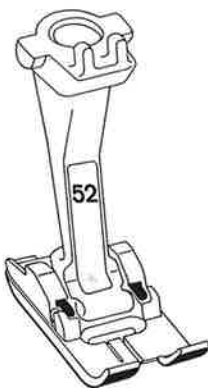

Long stitch

Long stitch

With the Long stitch, the machine sews every other stitch, giving a maximum stitch length of 10 mm. Long stitch can be sewn in any of the five needle positions.

Needle: 80

Thread: Sewing thread

● Stitch: -----
Straight stitch

Stitch length: 1½–5

Needle position: any position

● Function button: ---
Long stitch

For fine fabrics Long stitch can also be used for basting.

For Top stitching the Long stitch can be combined with the Triple straight stitch.

Top stitching using buttonhole thread (Cordonnet)

a) Buttonhole thread as the upper thread

Rule of thumb: Use size 110 needle.

With certain fabrics a size 100 needle could be large enough. Sew a test piece.

b) Buttonhole thread as the lower thread

If the thicker needle is unsuitable for the fabric, the buttonhole thread should be wound on the bobbin and used as the lower thread. If the sewing line is not visible, e.g. when sewing on pockets, mark the line with basting in a contrasting colour. This will show in the reverse side and can easily be removed when the work is completed.

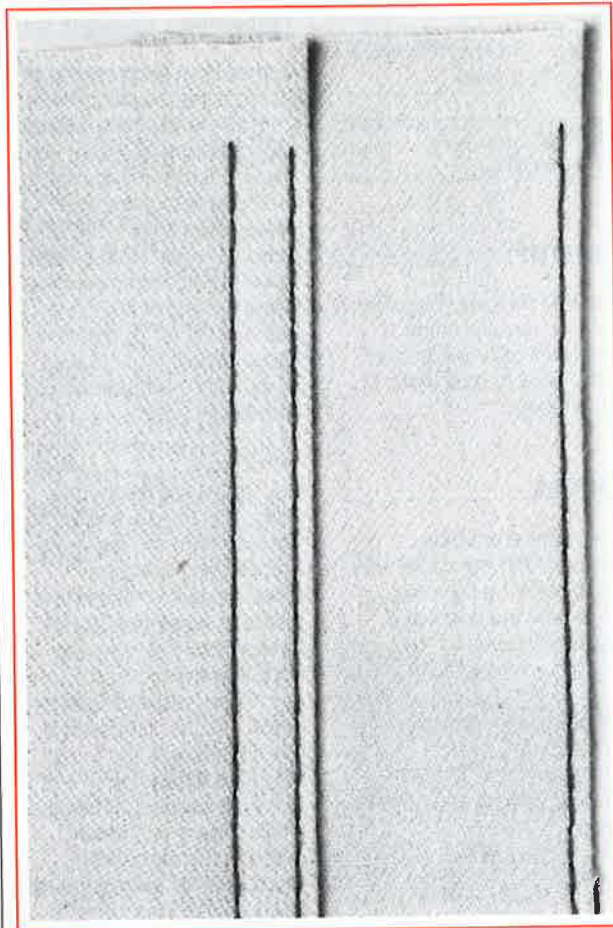

Blind hemming

Needle: 80-70

Thread: Sewing thread/
Darning thread

● Stitch: 
Blind stitch

Important

As with hand sewing, fine fabrics require a fine needle and a fine thread. This work is best done at slow speed.

Method

The hem should be prepared in the same way as for sewing by hand. Oversew the raw edge, baste and press.

Positioning the hem

The hem is positioned under the foot as shown in fig. 1.

Test piece

(Either on a scrap piece of fabric from the garment, or directly on the hem.) Given the variations in fabric thicknesses, it is advisable to sew a test piece first. As when sewing by hand, the needle should only catch the edge of the fabric. The basic setting is always a stitch width of 3. With the variations of fabric thickness, minor adjustments may be required.

Test piece:
Sew slowly to the point when the needle swings to the left. With the aid of the handwheel, bring the needle down until it is just about to enter the fabric. Check that it is only just catching the fabric. If necessary adjust the stitch width slightly: narrower if the needle is going in too far and a little wider if it is failing to catch sufficiently. Check the next zig-zag stitch in the same way. Then sew for approximately 10 cm (4") and check again.

Guiding the work

Guide the hem as shown in fig. 2.

Tip:

Whilst sewing, hold the under fabric back slightly.

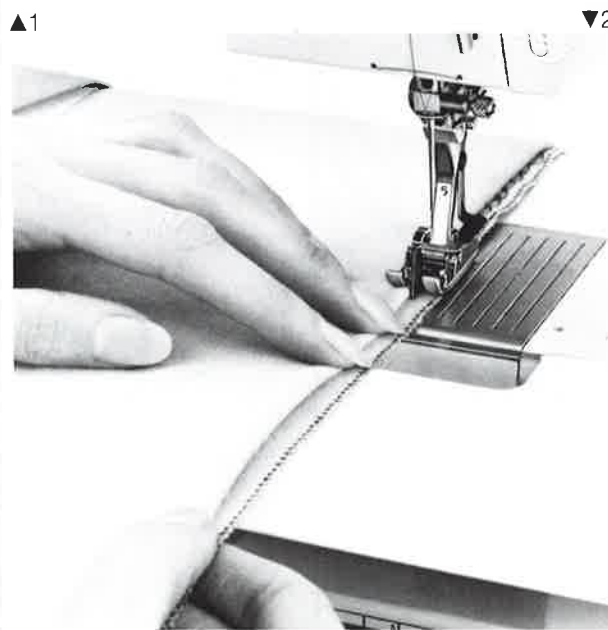
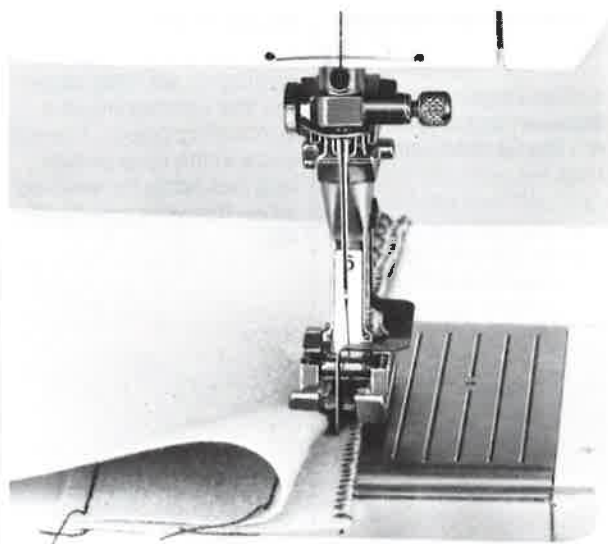
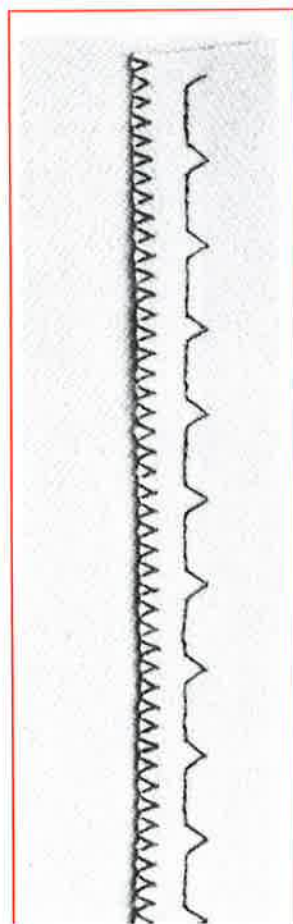

Edge stitching

Edge stitching

On collars, cuffs, lapels, hems etc.

Needle: 80

Thread: Sewing thread

● Stitch: -----
Straight stitch

Stitch length: as required

Needle position:
Left/half left for outer
edges (fig. 1)

Needle position:
Right for turned-in edges
(fig. 2)

Presser foot: No.5 Blind
stitch foot

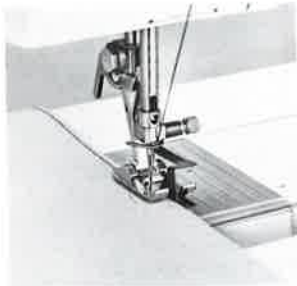

▲1

Place the edge of the fabric from the left, against the guide on the Blind stitch foot. Set the needle position to left or half-left. For longer stitches, use Long stitch.

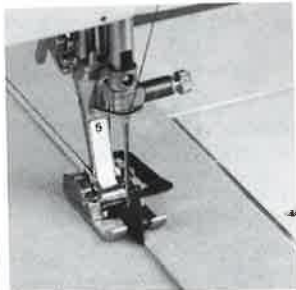

▲2

Position turned in edges to the right of the guide on the foot and select needle position right.

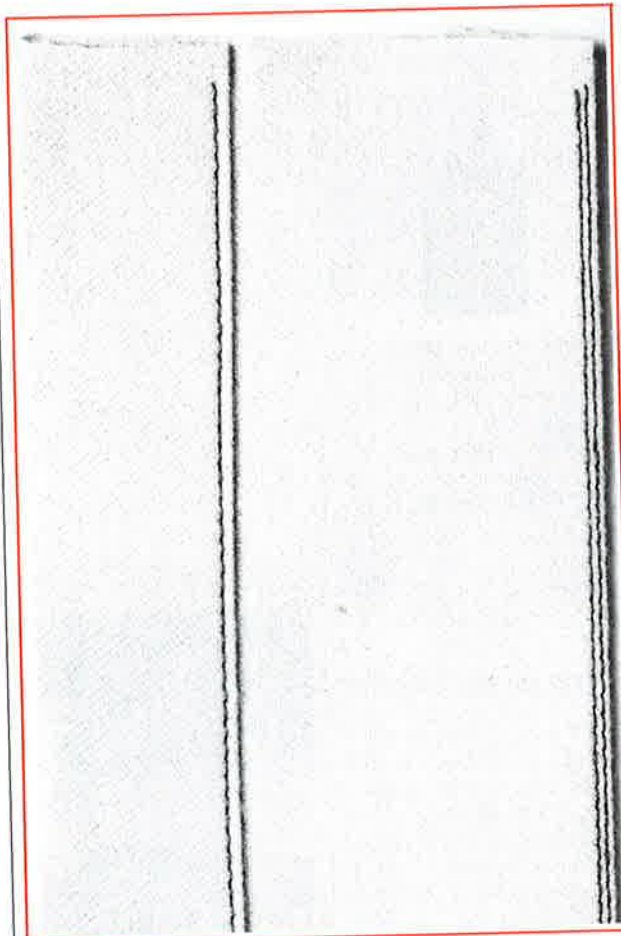

Top stitching

For edges of all kinds

Needle: 80

Thread: Sewing Thread

● Stitch: -----
Straight stitch

Needle position: any position

Guide the edge of the fabric to the outer edge of the presser foot or the marks in the needle plate. With the help of the 5 needle positions it is also possible to sew intermediate widths.

Widths:

Edge of presser foot = 7.5 mm
($\frac{3}{16}$ "
(fig. 3)

Guide lines on stitch plate

Line 1 = 1 cm ($\frac{3}{8}$ "

Line 2 = 1,5 cm ($\frac{5}{8}$ "
(fig. 4)

Line 3 = 2 cm ($\frac{3}{4}$ "

Line 4 = 2,5 cm (1"
(fig. 5)

Line 5 = 3 cm ($1\frac{1}{16}$ "

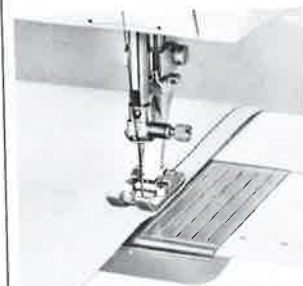

▲3



▲4

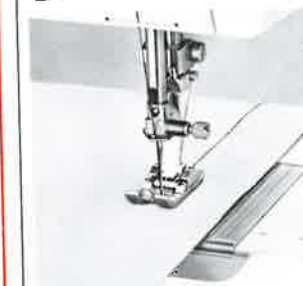

▲5

3-step buttonhole

Automatic buttonhole

Needle: 80-70

Thread: Embroidery thread
60/Darning thread, sewing
thread

Presser foot: no 3 or 3B

Method

When sewing buttonholes, thread the lower thread through the finger of the bobbin case.



Test piece

1. Press the buttonhole button.
 2. Always sew a test button hole on fabric exactly as garment.
 3. If necessary, adjust the stitch length to suit the fabric: Forward bead with the stitch length knob; reverse bead with the + or - balance button.
- Bead too dense = - button.
Bead too open = + button.

Altering the bead width

The width of the bead can be altered using the selector knob for stitch width (test).

Mark buttonholes

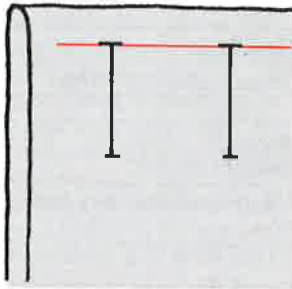

Sewing the buttonhole

Bring the needle to the centre of the presser foot with the aid of the hand-wheel or needle stop. Lower the needle into the fabric at the start of the buttonhole, lower the presser foot.



1. The machine will sew the first bead forwards. Stop the machine when the buttonhole is the desired length.



2. Press the buttonhole button. The machine will sew the bar tack and the reverse bead. Once again, stop the machine when the second bead is level with the first.



3. Press the buttonhole button. The machine will sew the bar tack and securing stitches. The machine will stop automatically and be ready to start the next buttonhole. On all further buttonholes, *do not press the buttonhole button* at the start of sewing. The machine is already set to sew the first bead (stage 1).

Foot with slide 3B

Sew the buttonholes as described above. After sewing the first bead adjust the slide on the side of the foot to the length of the bead. The length of all subsequent buttonholes is now marked.

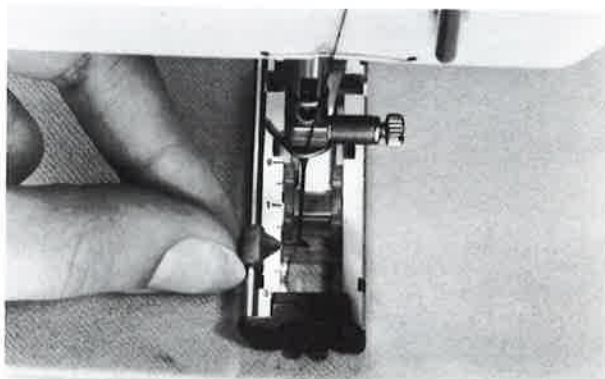

3-step buttonhole with gimp cord

The gimp cord strengthens the buttonhole.

The gimp cord is particularly important for all knitted fabrics – including hand and machine knits – to prevent the buttonhole from pulling out of shape. The thickness of the cord depends on the fabric to be sewn. Suitable cords are perle yarn no. 8, buttonhole thread, or fine crochet cord. Sew a trial buttonhole first. Lay the fabric under the foot so that the loop of the cord will come at the end of the buttonhole pulled by the button (fig. 1).

Positioning the cord

It is easier to position the cord if the needle is already in the fabric: Lower the needle into the fabric at the start of the buttonhole. Do not lower the foot yet.

Hook the gimp cord over the centre prong at the front of the buttonhole foot (fig. 1) and take both ends back under the foot (fig. 2). Lower the foot. Check that the cord is able to slide, i.e. that it is not trapped by the foot.

Sew the buttonhole. Do not hold the gimp cord. It must be able to slide. Finally, pull through the loop of cord.

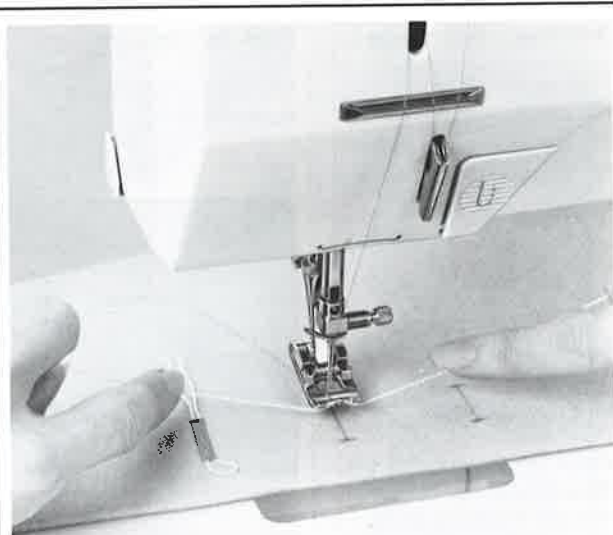

▲1

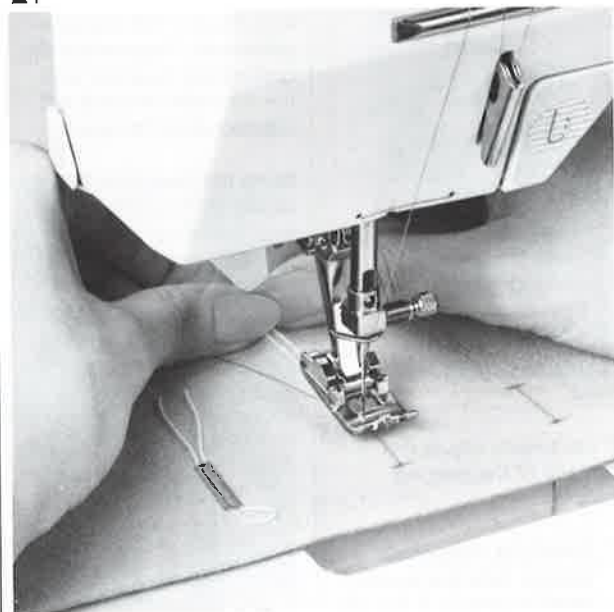

▲2

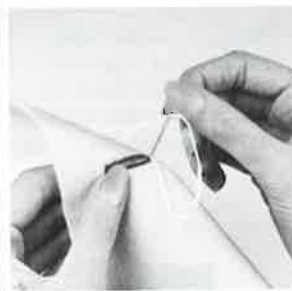

▲3

Securing the gimp cord

In knitted fabrics, pull the ends of the cord through to the back using a coarse hand sewing needle (fig. 3) and tie or sew in securely. (In woven fabrics, the cord ends can be simply cut off.)

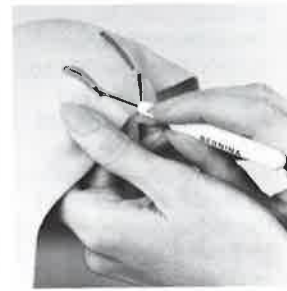

▲4

Cutting the buttonhole open

It is best to cut from both ends towards the centre of the buttonhole (fig. 4). This avoids cutting through a bar tack.

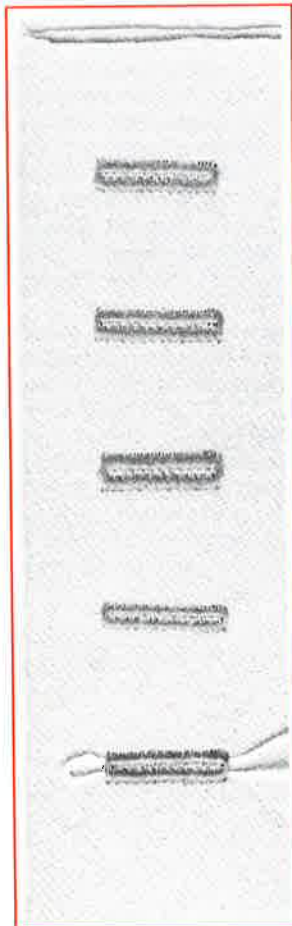

Automatic buttonhole

Automatic buttonhole

Presser foot: 3 or 3B

Needle: 80-70

Thread: Embroidery thread
60/Darning thread, sewing
thread

Method

When sewing buttonholes, thread the lower thread through the finger of the bobbin case.



Test

If necessary adjust the density of the second bead.

1. Press the buttonhole button. Sew the forward bead and stop at the desired length of the buttonhole.
2. Press the buttonhole button. Sew the first bar tack and the reverse bead. After approx. 20 stitches stop the machine. Adjust the density to match the first bead (bead too dense = - button; bead not dense enough = + button). Complete the bead.
3. Press the buttonhole button until buttonhole begin is indicated.
4. Sew the 2nd buttonhole and programme it with the altered stitch length as described under «Programming Buttonholes».

Mark buttonholes

Mark the length of one buttonhole.

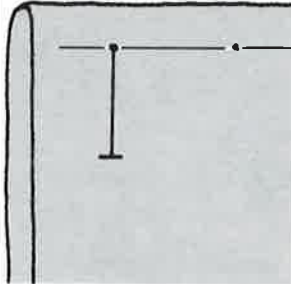

Programming Buttonholes

The automatic buttonhole can be sewn with presser foot no. 3 or 3B and programmed. Programme the buttonhole together with the foot with which it will subsequently be sewn.

Bring the needle to the centre of the presser foot with the aid of the hand-wheel or needle stop. Lower the needle into the fabric at the start of the buttonhole and lower the presser foot.



1. Press the buttonhole button. The machine sews the first bead forwards. Stop the machine at the desired length.



2. Press the securing control. Sew the bar tack and the second bead in reverse. Stop at the desired length.



3. Press the securing control. Sew the bar tack and securing stitches. The machine stops and is automatically set for buttonhole begin. All subsequent buttonholes are now programmed in the desired length.

Automatic buttonhole with gimp cord

The gimp cord strengthens the buttonhole

The gimp cord is especially important for all knitted fabrics – including hand and machine knits – to prevent the buttonhole from pulling out of shape. The thickness of the cord depends on the fabric to be sewn. Suitable cords are: perle cord no. 8, thick hand sewing thread or fine crochet cord. Sew a trial buttonhole. The loop of gimp should lie at the end of the buttonhole where the button will pull. Lay the fabric under the presser foot accordingly (Fig. 1).

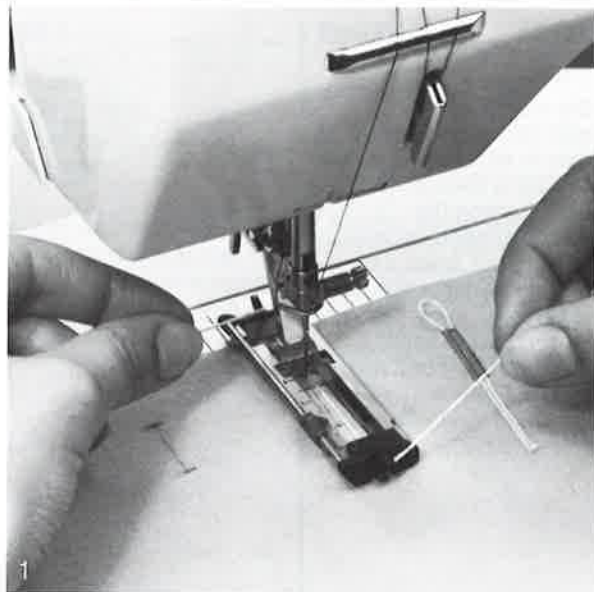

Positioning the cord

It is easier to position the cord if the needle is already in the fabric. Bring the needle to the centre of the presser foot using the handwheel or needle stop. Lower the needle into the fabric precisely at the start of the buttonhole. Do not lower the foot yet.

Guide the cord to the right under the buttonhole foot and hook it over the prong at the back (Fig. 1). Then bring it round to the left and forwards under the foot. Pull the ends of the cord into the retaining slots at the front (Fig. 2) and trim away any surplus.

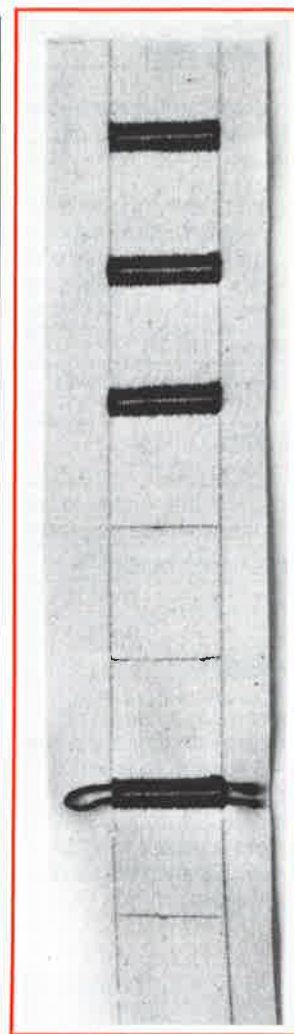
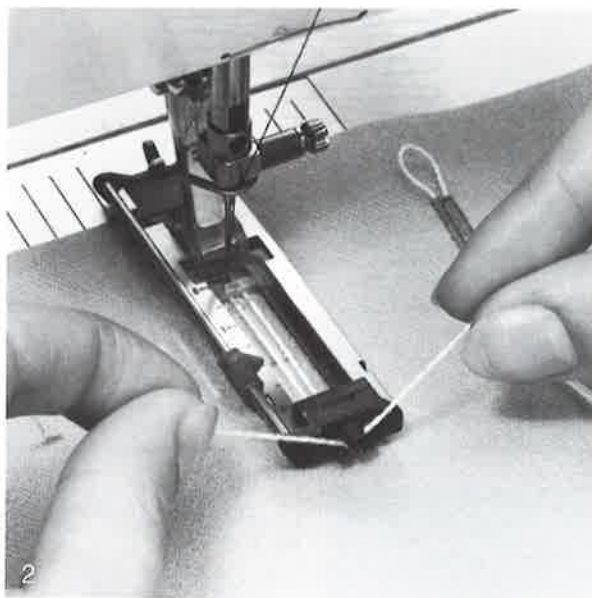

To secure the gimp cord and cut the buttonhole open, see page 41.

Mending woven fabric

Mending tears using Running stitch

Modern darning method for tears and thin areas on virtually all fabrics.

Needle: 80-70

Thread: Darning thread

● Stitch: 
Running stitch

Stitch length: Adjust to suit the fabric where necessary

● Function button: 

Important:

Always lay a fine fabric underneath. On tears, sew 3-5 rows of Running stitches (fig. 1).

On thin areas, sew sufficient adjacent rows to cover. Overlap the rows very slightly.

Method

On flat garments it is possible to turn the work, lower the needle into the fabric to do this, so the stitching is always in a forward direction (fig. 1).

On tubular items (sleeves, trouser legs), press the reverse sewing button after the first row, move the fabric sideways slightly, and sew the second row in reverse. Continue, alternating forwards and reverse (fig. 2).

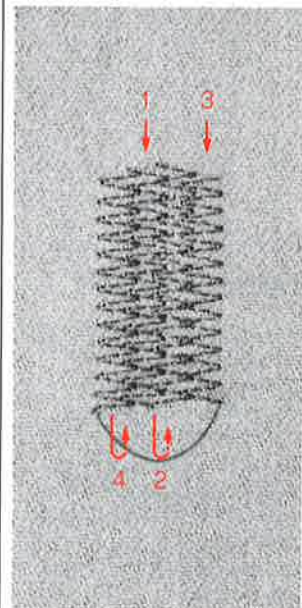
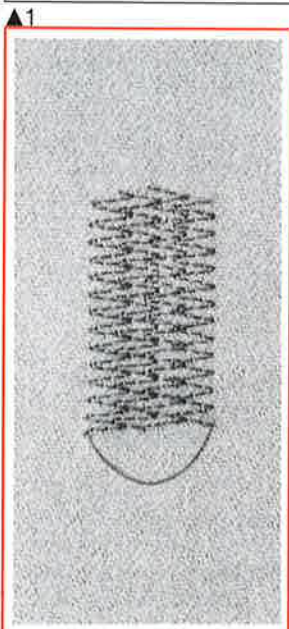
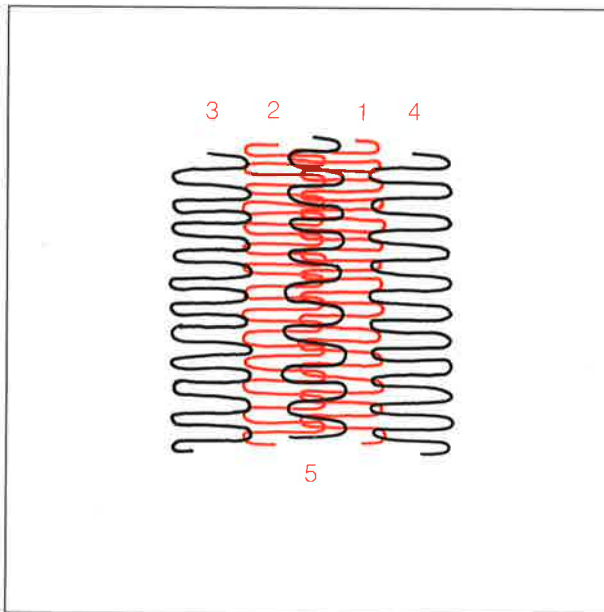

Mending woven fabric

Patching using Honeycomb stitch or Running stitch (according to fabric)

For outerwear and especially jeans.

Needle: 80

Thread: Darning thread

Step 1

● Stitch: -----
Straight stitch

● Function button: ---
Long stitch

Do not cut away worn/torn areas. Pin patch to the right side and baste along the edge using darning thread.

Step 2

Clear Long stitch

● Stitch: 
Honeycomb stitch

Oversew edges with Honeycomb stitch. Guide the edge of the patch to the right of the zig-zag slot of the foot to ensure all Honeycomb stitches are on the patch.

Step 3

● Stitch: -----
Straight stitch

Stitch length: approx. 1

Sew a straight stitch along the inside edge of the Honeycomb stitch. Then cut away the worn/torn piece from behind patch. This is easier with the straight stitch.

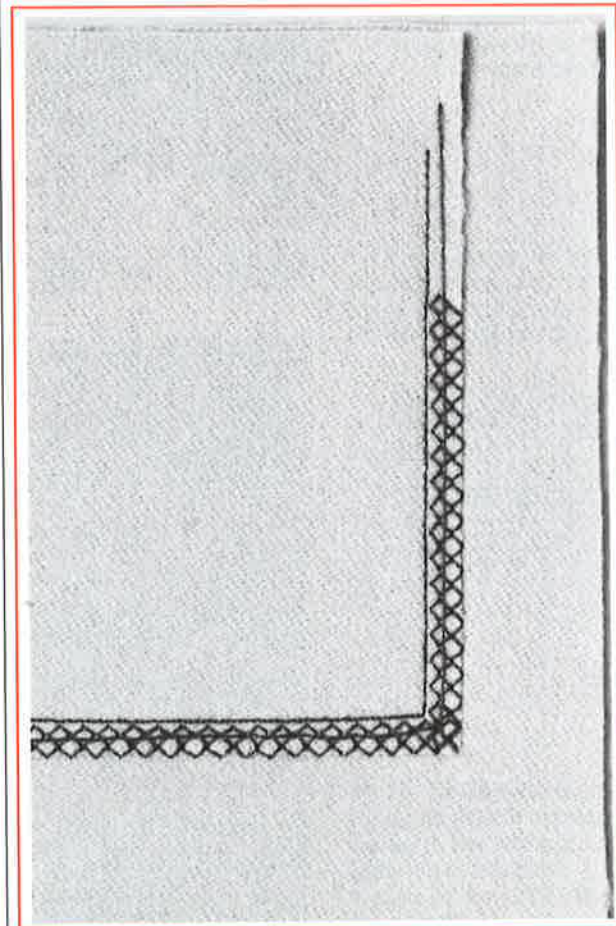

Mending interlock fabric

Patching using Jersey stitch

Primarily for mending interlock underwear.

Needle: 80–70

Thread: Darning thread

● Stitch: 
Jersey stitch

Small tears/worn areas are best darned. See page 47. For larger tears or worn areas, it is better to sew on a patch as this retains the elasticity.

Cut out a patch, possibly from the sound part of similar discarded garment. Where possible round off the corners to preserve elasticity.

Pin on the patch and baste as close as possible to the edge using small stitches. Then sew patch into place using 1–2 rows of Jersey stitch. Finally, cut away torn/worn piece from behind patch.

Edging with elastic thread

The elastic thread is used to restore distorted edges to their original shape.

Needle: 80–70

Thread: Darning thread

● Stitch: 
Zig-zag stitch

Stitch width: approx. 5

Stitch length: 1–1½

Guide two strands of elastic thread along the edge and sew in place with zig-zag stitch, gently pulling on the elastic thread.

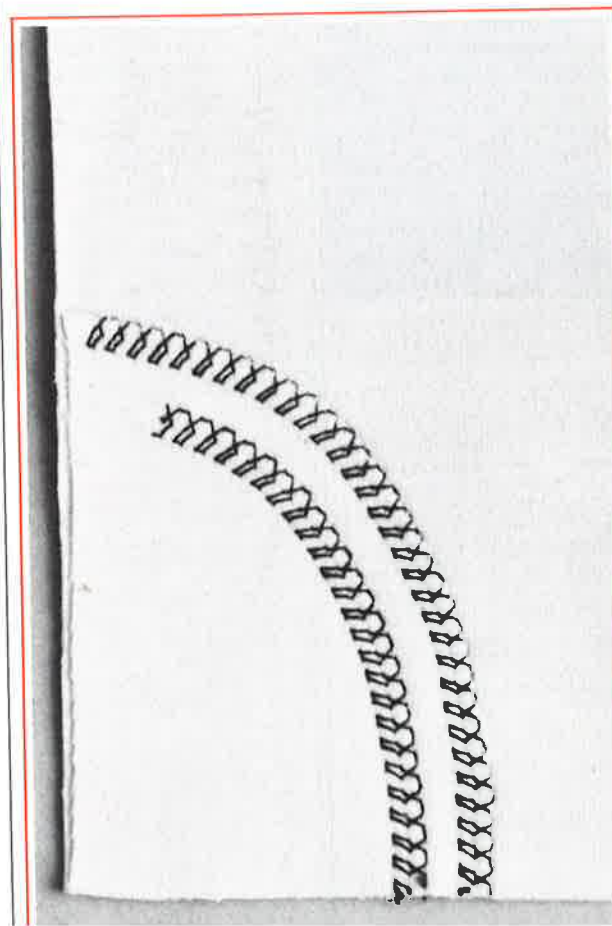

Darning

The principle of darning

The feed-dog must be lowered for darning as the work is moved to and fro by hand and not by the feed-dog. It is important to guide evenly when darning and this will take a little practice.

Recommendation

Whenever possible, use a darning ring to keep the darning area taut. Move the ring backwards and forwards without pressure, otherwise jerky movements occur, resulting in torn threads. Always work from left to right, moving up and down over the hole, not from side to side. Finish each stage with needle in fabric on the right and pivot the work 90° (except with tubular items). Work is guided with little finger and thumb to the outside of the hoop, held firmly to give a smooth movement. Use the sewing table and support the elbows on the work table. Position the machine slightly further back from the edge of table than normal.

Darning technique

There are various methods of darning. The method described here is one that is easy to learn:

Needle: 80-70

Thread: Darning thread

● Stitch: - - - - -
Straight stitch

Stitch length: 0

Feed-dog: lowered

Presser foot: Darning foot
No. 9

Important

Darn in a curved rather than a pointed shape, otherwise the fabric is liable to tear. Beginners often tend to prefer L and M movements, but care must be taken to ensure that this does not result in a circular movement (fig. 1).

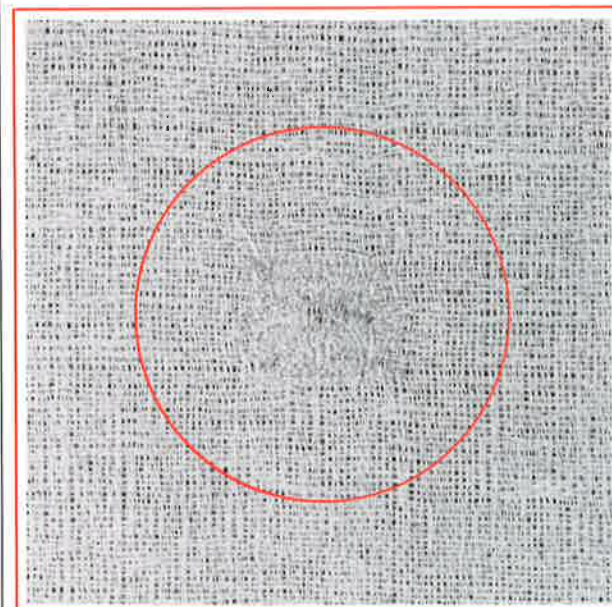
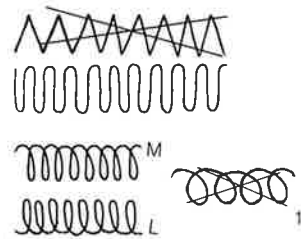

Main faults:

Thread frequently breaks:
– Fabric being guided unevenly.

Stitching unattractive, thread loose on top:
– Fabric being moved too quickly.

Small knots form on underside:
– Fabric being moved too slowly.

The three steps

1. Start at top left of darn, work from left to right across hole, finishing at top right. Turn 90°.

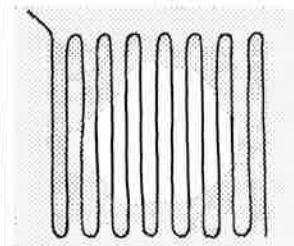

2. Again work from left to right, filling in hole, but not too densely otherwise a ridge will form at the edges of the darn.

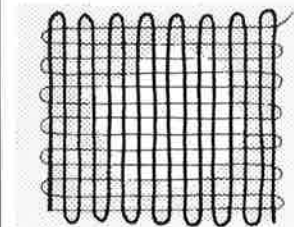

3. Fill in the darn, working in same direction as step 2, but only over the "hole", not to the edge of the darn.

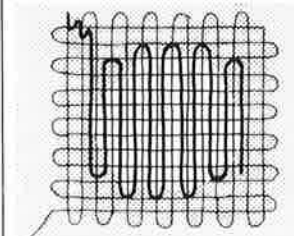

When the darning technique has been mastered, work the rows of stitches in irregular length so the darn blends into the fabric.

Darning with small darning ring

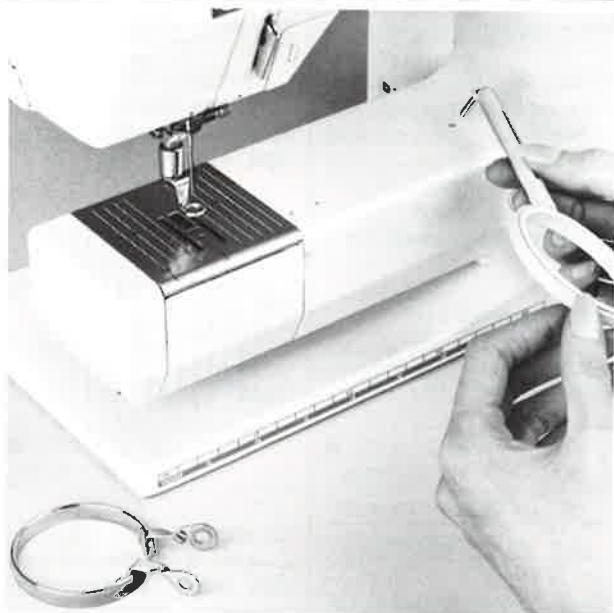

▲1



▲2

▼3

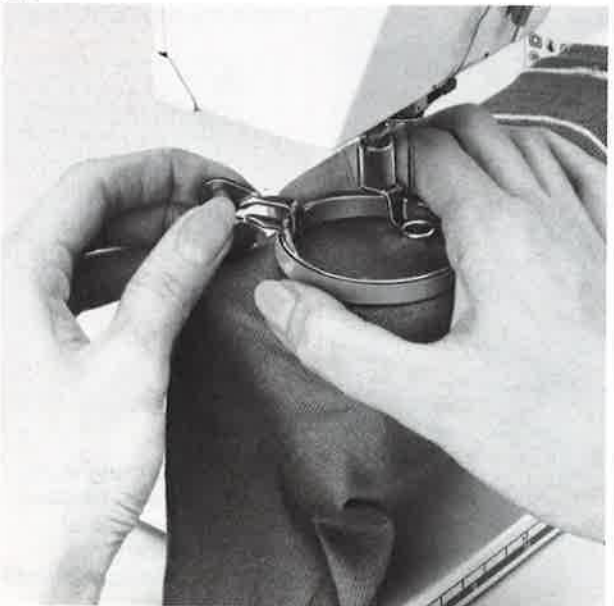

The small darning ring

The small darning ring is particularly practical for darning small torn/worn areas in fine fabrics and in fine underwear, fine socks and pullovers, e.g. in Helanca, interlock, jersey.

Stretching the work

- Fit the darning ring, without the spring clip, on to the free arm (fig. 1).
- Slide the garment over the free arm going also over the darning ring.
- Push the darning ring as far as possible to the left. Place the index finger and the thumb of the right hand on the darning ring, to form a circle.
- With the left hand, stretch the fabric over the end of the free arm. Hold the tensioned fabric with the thumb of the right hand. Using the left hand, fit the spring clip as follows:
Close the spring clip, insert under the index finger of the ring hand and hold firmly. Then press the spring clip down into the ring (fig. 3).

Darning technique

Tubular items are usually stitched up and down and then side to side as it is not possible to turn the work.

Trouble-shooting Maintenance

Fault prevention	50
Changing the bulbs	51
Maintenance: Cleaning and oiling	52

Fault prevention

If the sewing machine does not sew properly, it is usually due to incorrect operation.

Check whether:

- The upper and lower threads are correctly threaded.
- The needle was correctly inserted, with the flat side of the shank to the rear.
- The needle size is correct. See needle and thread table.
- The machine is clean. Brush out any remnants of thread.
- The hook race is clean and oiled.
- Any remnants of thread are trapped between the thread tensioning discs and beneath the bobbin case spring.

Upper thread breaks

- The upper thread tension is too tight.
- Poor quality needles. Ideally, needles should be purchased from a BERNINA dealer.
- The needle has been fitted incorrectly. The flat side of the shank must be to the rear.
- The needle is blunt or bent.
- Poor quality thread, knotted or dried out thread.
- Stitch plate or hook tip damaged. Take to a BERNINA dealer.

Lower thread breaks

- The lower thread tension is too tight.
- The bobbin is jamming in the bobbin case. Replace bobbin.
- The hole in the stitch plate has been damaged by the needle. This must be re-polished by an expert.
- The needle is blunt or bent.

Faulty stitching

- Wrong needles. Use only 130/705 H needle range.
- The needle is blunt or bent, or incorrectly fitted. Push right to the top when inserting.
- Poor quality badly polished needle.
- The needle point does not suit the fabric being sewn. If necessary, use ball point for knitted fabrics and cutting point for hard leather.

Needle breaks

- Needle clamping screw not sufficiently tightened.
- Fabric withdrawn forwards instead of backwards, under the presser foot.
- When sewing over a thick area, the fabric was pushed while the needle was still in the material. Use the Jeans foot.
- Poor quality thread, unevenly wound or knotted.

Faulty tension

- Remnants of thread between the thread tensioning discs.
- Remnants of thread under the bobbin case spring.
- Lower thread still threaded in the bobbin case finger.
- Threaded with foot down.
- Incorrectly threaded. Check lower and upper threads.

Machine fails to run, or will only run slowly

- Plug is not properly inserted.
- Power switch in 0 position.
- Reduced speed button (32) is selected.
- Machine gummed up by unsuitable oil. Machine will have to be cleaned by a specialist.
- Machine has been standing in a cold room.

Machine stitching in reverse

- Selector button (33), "Reverse sewing" is still engaged.

Machine is not sewing selected programme

- Switch machine off, then on again, using the power switch.

If you have occasion to take your machine to a specialist, always ensure that you also take the foot control and accessories!

Changing the bulbs

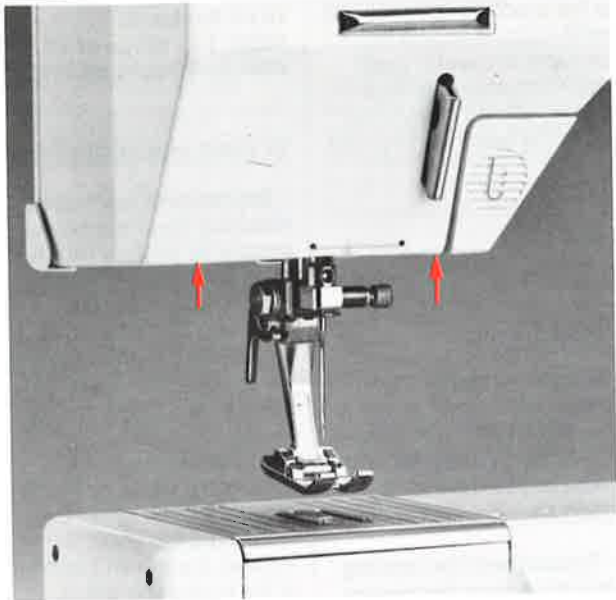

Fitting the bulbs

There are 2 low voltage 6 volt/4 watt bulbs provided. The first is located in front to the left of the presser foot, the other behind, to the right.

Disconnect the machine from the mains by removing the mains plug from the socket!

WARNING:

Please refer to the safety instructions.

Changing bulbs

To change the front bulb: (fig. 1) Using special tool A, press the bulb upwards, twist to the left and withdraw.

To change the rear bulb

(fig. 2)

Remove diffuser B. The bulb can then be removed in the same way as the front bulb.

To insert new bulbs

Place the new bulb on the special tool (fig. 3). Insert into holder with the bulb, press upwards and twist to the right, to the stop. For the rear bulb, refit diffuser B.

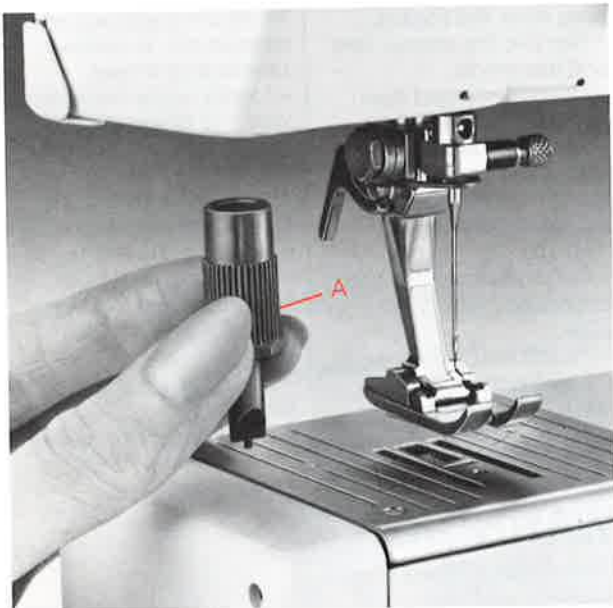

▲1

▼2

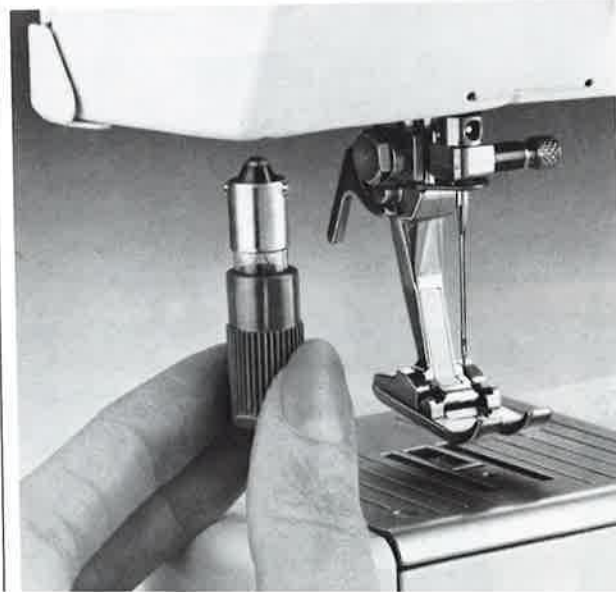
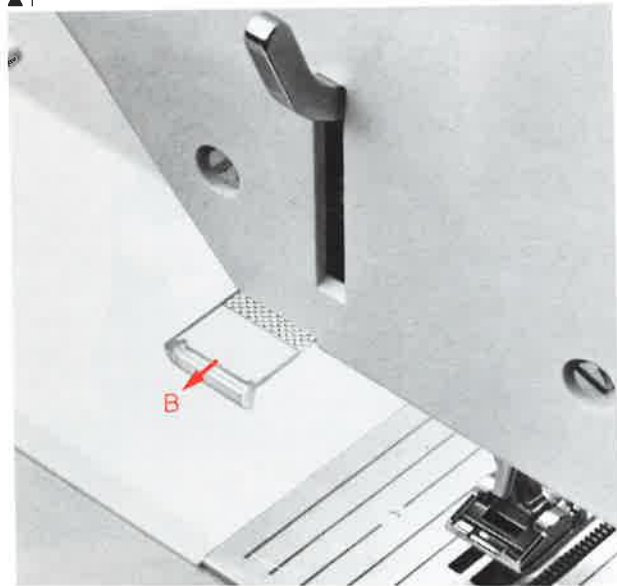

▼3

Maintenance: Cleaning and Oiling

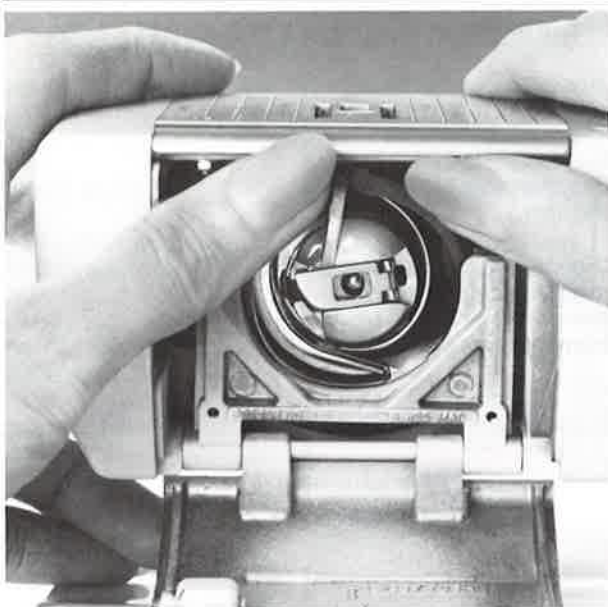

▲1

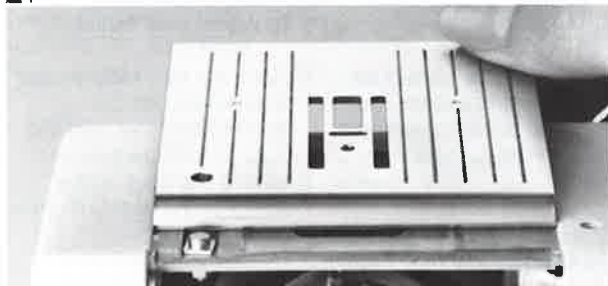

▲2

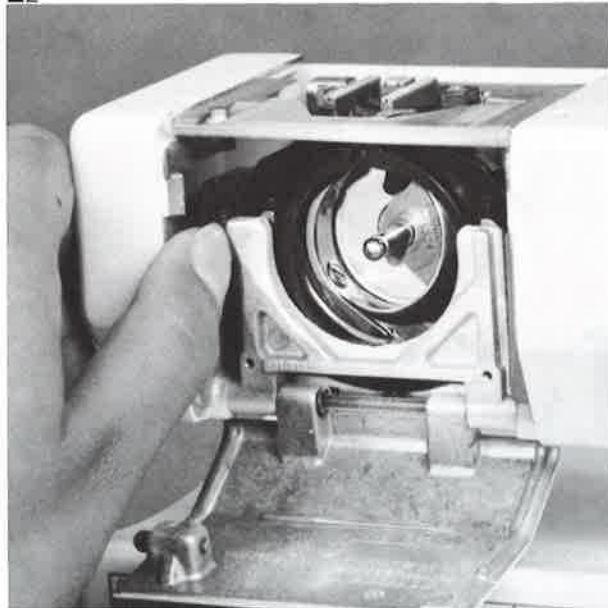

▲3

▼4



If the machine is stored in a cold room, it should be brought to a warm room approximately one hour before use, to restore the oil in the bearings to a fluid state.

Cleaning

When sewing, pieces of thread will collect under the stitch plate and around the hook. These remnants must be removed at regular intervals.

– **Disconnect the sewing machine from the power supply by pulling out the plug from the socket.**

– Remove the presser foot and the needle.

– Open the hinged front cover on the free arm.

– Lower the feed-dog. Set knob 18 to position . Using both thumbs, press the stitch plate up and back (fig. 1).

– Clean the feed-dog and underside of the stitch plate.

– To refit the stitch plate on the free arm, insert the stitch plate from the rear, push forward until it engages (fig. 2).

WARNING:

Please refer to the safety instructions.

To oil the hook:

Apply 1–2 drops of oil after 3–4 hours sewing.

To clean and oil the hook

– **Disconnect the sewing machine from the power supply by pulling out the plug from the socket.**

– Take out the bobbin case, see page 12.

– With the thumb of the left hand, press the lower release lever to the left (fig. 3).

– Fold down the semi-spherical locking strap with the black hook race cover.

– Take out the hook.

– Clean the top and bottom of the hook race with a brush and cotton cloth. Never use a screwdriver or scissors etc. to remove remnants of thread.

– Lightly oil the hook race with 1–2 drops of oil (fig. 4).

– Insert the hook. If necessary, turn with the handwheel until the hook driver is on the left (fig. 5).

– Close the black hook race cover and locking strap. The pawl must engage.

– Check by turning the handwheel.

– Insert the bobbin case.

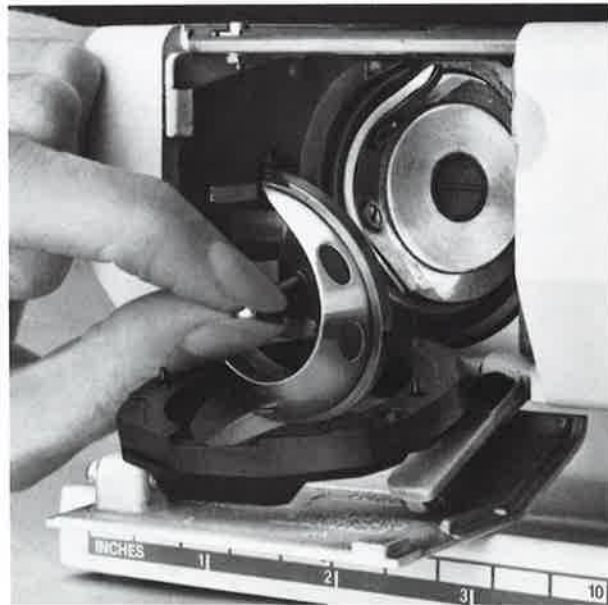

▼5

Bernina publications

It is not possible to cover more than the basics of sewing in an instruction manual. However, the creative potential of your Bernina sewing machine and Bernina overlocker is enormous. To help you use your machines to the full, Bernina regularly publishes sewing literature which covers everything from simple techniques to advanced fashion projects. Your Bernina Dealer will be delighted to give you more information.

Sewing Service Leaflets

Each issue of our Sewing Service Leaflets deals with a particular sewing technique presented in easy to follow steps. Success is guaranteed!

Bernina Creative Sewing

The Bernina Creative Sewing magazine appears twice yearly. Fashion, Bernina Studio, home decoration, sewing for teens and twens and craft projects are all regular features of the magazine. Special sewing techniques which are featured in the sewing projects are described in detail in words and pictures. Unusual and imaginative ideas are also included from enthusiastic sewers around the world. Read about new sewing developments and trends in the comfort of your own home. The Creative Sewing magazine is a source of inspiration for all sewers. Ask your Bernina Dealer and learn how to get the most out of your machines.

Bernina Collection

These booklets deal with one particular theme in all its variations. Basic information, pattern suggestions, detailed sewing instructions with coloured illustrations and many tips and tricks of the trade will turn you into a sewing pro in no time at all. They are issued two to three times a year, so be sure to ask your Bernina Dealer when the next one is expected.



Sollte diese Maschine in ein anderes Sprachgebiet verkauft werden, fordern Sie beim nationalen Importeur oder Bernina-Händler eine Bedienungsanleitung in der entsprechenden Sprache an.

If this machine has been purchased in a foreign country, please request an instruction manual in your own language from the national Importer or a Bernina dealer.

Si cette machine est vendue dans une autre région linguistique, demandez à l'importateur national ou à l'agent Bernina, un manuel d'instructions dans la langue correspondante.

In caso questa macchina fosse venduta in un territorio di lingua diversa si prega di richiedere il libretto d'istruzione nella lingua adeguata presso l'importatore nazionale oppure presso un rivenditore Bernina.

Si esta máquina se vende en otra región lingüística entonces pida Vd. de su importador nacional o del representante Bernina un manual de instrucciones en el idioma correspondiente.

Indien deze machine in een ander taalgebied werd gekocht, kunt u bij de nationale importeur of Bernina vakhandelaar een handleiding in de overeenkomstige taal aanvragen.

Skulle denne maskine blive solgt i et andet sprogområde, bedes du henvende dig hos den nationale Bernina-importør eller en Bernina-forhandler, hvor du kan købe en brugsanvisning på det ønskede sprog.

Om den här maskinen har köpts i ett annat land, var vänlig beställ en instruktionsbok på Ditt eget språk från importören eller en Bernina-återförsäljare.

Er denne maskinen kjøpt i utlandet, kan instruksjonsbok bestilles på ditt eget språk fra Bernina importøren eller nærmeste Bernina forhandler.

Tarvittaessa voit tiedustella omakielistäsi käyttöohjekirjaa Bernina-maahantuojalta tai jälleenmyyjältä.

SE ESTA MÁQUINA FOI COMPRADA NUM PAÍS ESTRANGEIRO, DEVER-SE-À PEDIR O MANUAL DE INSTRUÇÕES NAQUELA LÍNGUA AO IMPORTADOR NACIONAL OU AO FORNECEDOR DA BERNINA.

ΑΝ Η ΜΗΧΑΝΗ ΕΧΕΙ ΑΓΟΡΑΣΤΕΙ ΣΕ ΜΙΑ ΞΕΝΗ ΧΩΡΑ, ΠΑΡΑΚΑΛΩ ΖΗΤΗΣΤΕ ΕΝΑΝ ΟΔΗΓΟ ΛΕΙΤΟΥΡΓΙΑΣ ΣΤΗΝ ΔΙΚΗ ΣΑΣ ΓΛΩΣΣΑ ΑΠΟ ΤΟΝ ΓΕΝΙΚΟ ΑΝΤΙΠΡΟΣΩΠΟ ΤΗΣ BERNINA Η ΑΠΟ ΤΟΥΣ ΠΩΛΗΤΕΣ ΤΗΣ BERNINA.

BERNINA®

© Copyright by Fritz Gegauf AG, Steckborn

971 GB 006.919.52.04 Printed in Switzerland/ELB