

BERNINA®

Instruction Manual & Sewing Manual

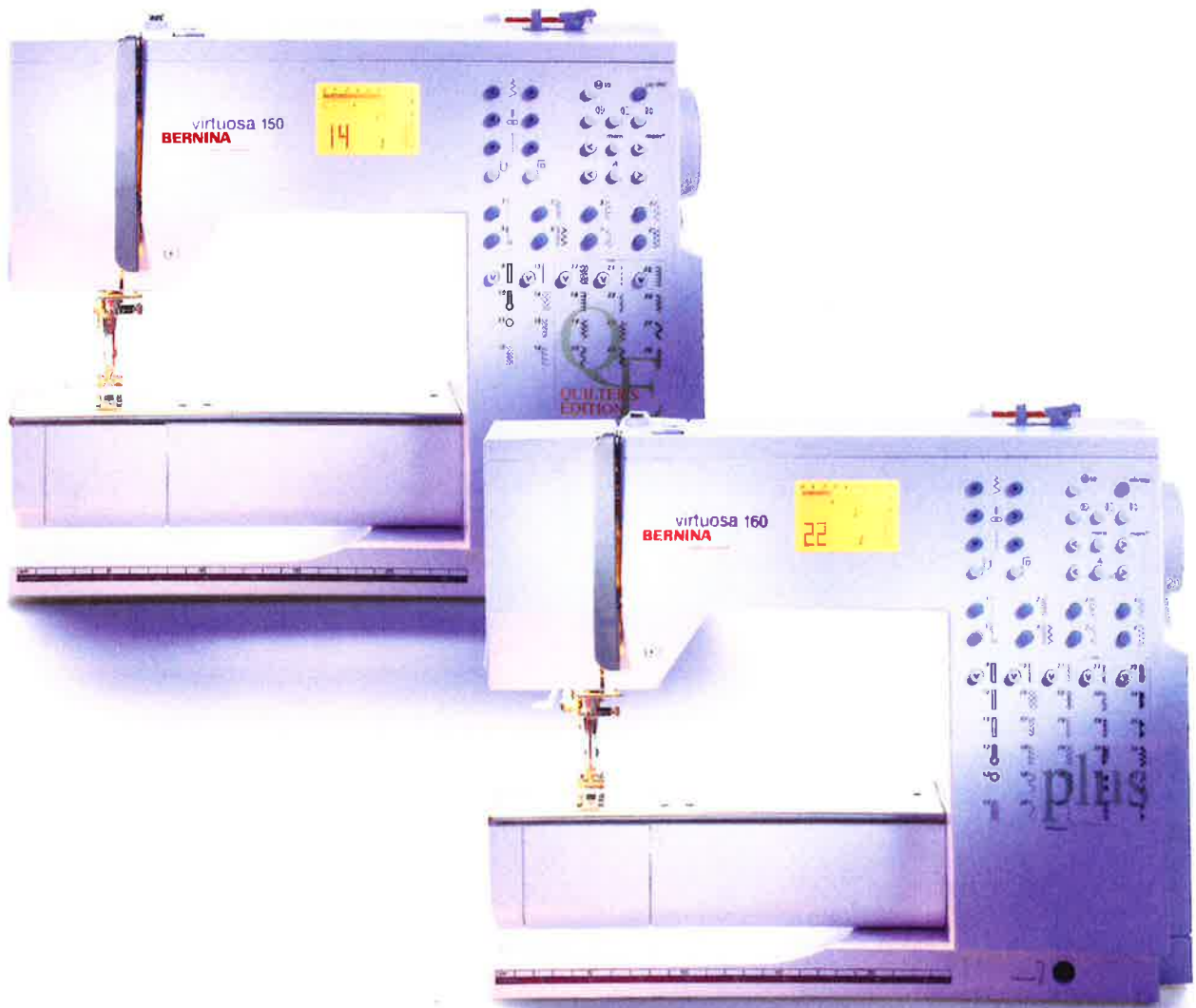

virtuosa 150
BERNINA®

Made in Switzerland

QE
QUILTER'S
EDITION

virtuosa 160
BERNINA®

Made in Switzerland

IMPORTANT SAFETY INSTRUCTIONS

When using an electrical machine, basic safety precautions should always be followed, including the following.

Read all instructions before using this sewing machine.

When the machine is not in use, it should be disconnected from the electricity supply by removing the plug from the outlet.

DANGER

To reduce the risk of electric shock:

1. A machine should never be left unattended when plugged in.
2. Always unplug this machine from the electric outlet immediately after using and before cleaning.
3. Always unplug before replacing light bulb. Replace the bulb with the same type rated 12 volts/5 watts.

WARNING

To reduce the risk of burns, fire, electric shock or injury to persons:

1. Do not allow to be used as a toy. Close attention is necessary when this machine is used by or near children.
2. Use machine only for its intended use as described in this manual. Use only attachments recommended by the manufacturer as contained in this manual.
3. Never operate this machine if
 - it has a damaged cord or plug
 - it is not working properly
 - it has been dropped or damaged
 - it has fallen into water
 Return the machine to the nearest authorized **BERNINA** dealer or service center for examination, repair, electrical or mechanical adjustment.
4. Never operate the machine with any air openings blocked. Keep ventilation openings of the sewing machine and foot control free from accumulation of lint, dust and loose cloth.
5. **Keep** fingers away from all moving parts. Special care is required around the sewing needle.
6. Always use the **BERNINA** original needle plate. The wrong plate can cause the needle to break.
7. Do not use bent needles.

8. Do not pull or push fabric while stitching. It may deflect the needle causing it to break.
9. Turn power switch to «0» when making any adjustments in the needle area, such as threading or changing the needle, threading the bobbin or changing the presser foot.
10. Always unplug the sewing machine from the electrical outlet when removing covers, lubricating or when making any other user servicing adjustments mentioned in this instruction manual.
11. Never drop or insert any object into any opening.
12. Do not use outdoors.
13. Do not operate where aerosol (spray) products are being used or where oxygen is being administered.
14. Before disconnecting, turn all controls to the off («0») position then remove the plug from the outlet.
15. Do not unplug by pulling on the cord but grasp the plug.
16. No responsibility will be taken for any possible damage as the result of misuse of the machine.
17. This machine is provided with double insulation. Use only identical replacement parts. See instructions for Servicing of Double-Insulated machines.

SERVICING DOUBLE-INSULATED PRODUCTS

In a double-insulated product, two systems of insulation are provided instead of grounding. No grounding means is provided on a double-insulated product nor should a means for grounding be added to the product. Servicing a double-insulated product requires extreme care and knowledge of the system and should only be done by qualified service personnel. Replacement parts for a double-insulated product must be identical to those parts in the product. A double insulated product is marked with the words «DOUBLE INSULATION» or «DOUBLE INSULATED».

The symbol  may also be marked on the product.

SAVE THESE INSTRUCTIONS!

This sewing machine is intended for household use only.

BERNINA®



"Welcome to
the BERNINA
family"

H.P. Ueltschi

H.P. Ueltschi
Owner BERNINA
Sewing Machine Company

Choosing **BERNINA** is a decision which will have a **positive impact** on your sewing **for years** to come. Customer satisfaction has been the driving force of our family company for over 100 years and **I intend to continue** that tradition of delivering superb Swiss quality, future-oriented sewing technology and unparalleled customer service.

The new **BERNINA family of creative sewing machines** gives you the unique opportunity to select a la carte what you need to satisfy **your sewing needs** and requirements.

In addition a **wide range of sewing accessories** together with supportive educational **publications full of practical and creative ideas** add to the joy of sewing the BERNINA WAY.

It gives me **great pleasure to welcome you** into the BERNINA family.

Setting up the machine

Operating instructions

Stitches
Presser feet

Needle and thread
Fabric feed

Cleaning
Maintenance
Trouble shooting

Index

4 **Details of the machine**

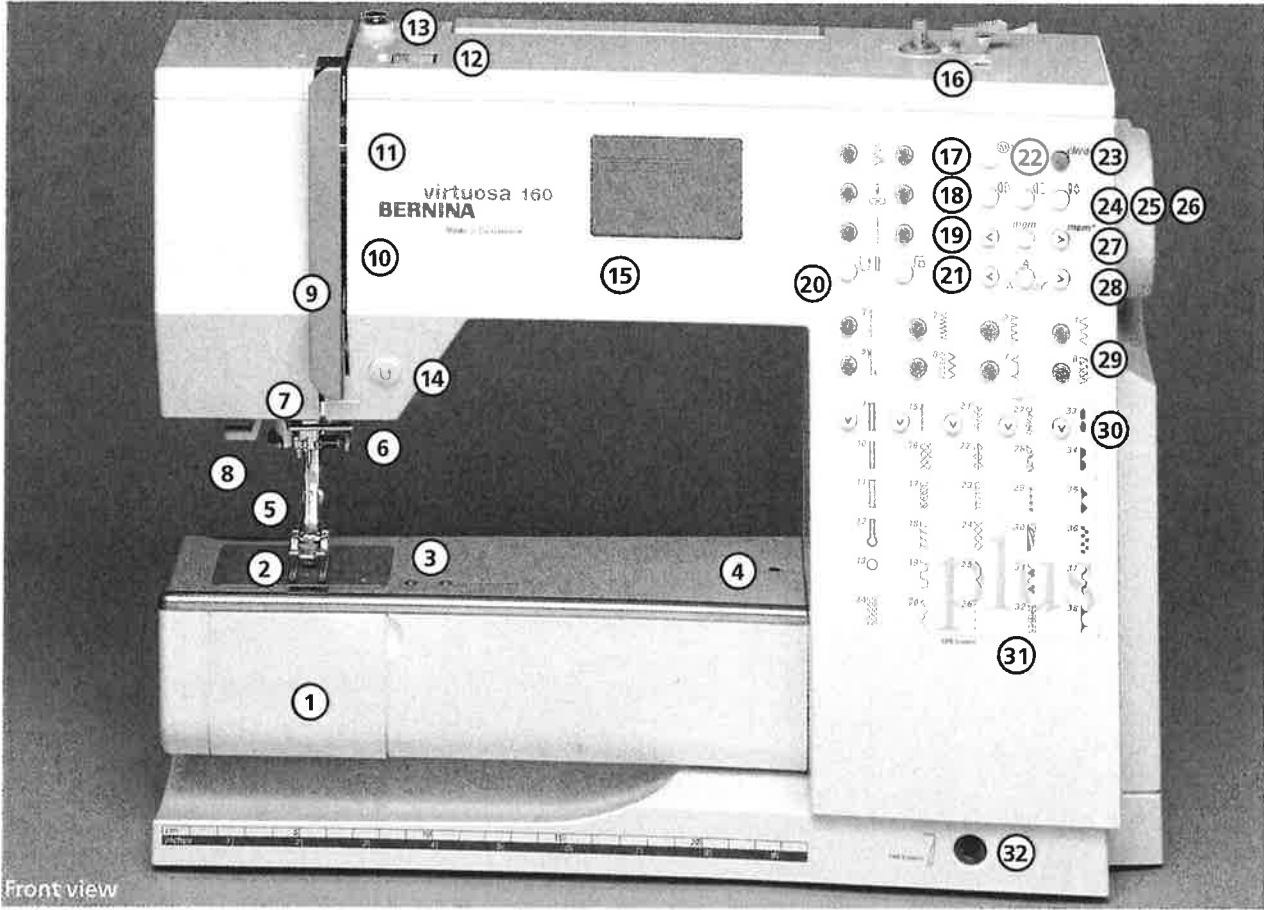

Front view

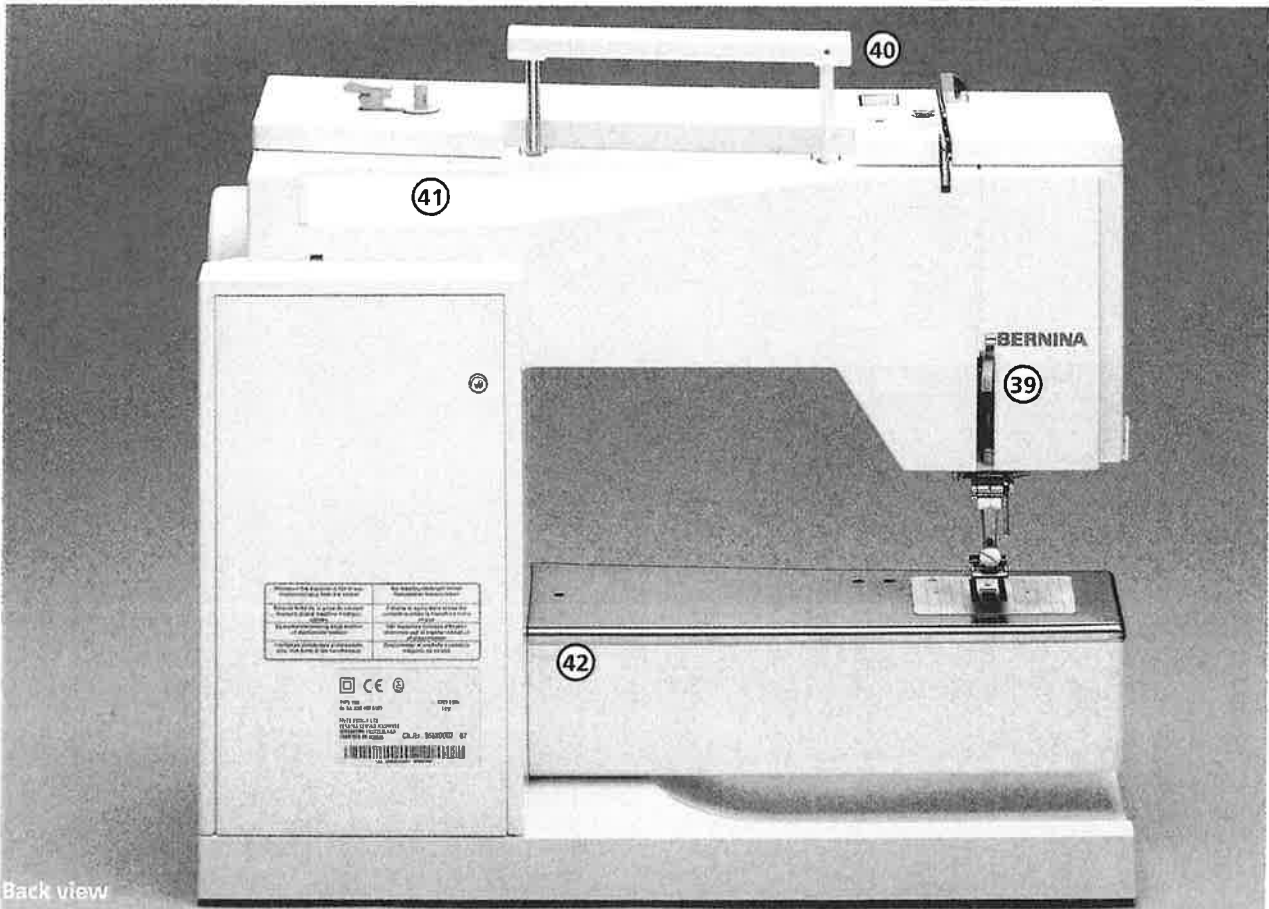

Back view

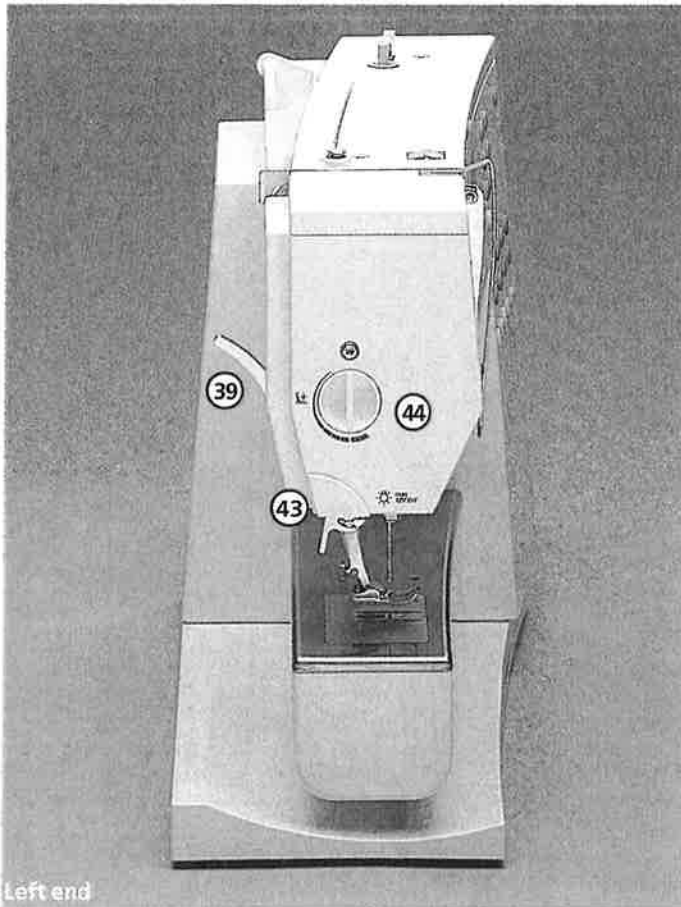

- 1 Bobbin cover
- 2 Stitch plate
- 3 Attachment base
- 4 Darning ring fixation hole
- 5 Presser foot
- 6 Needle clamp
- 7 Thread guide
- 8 Needle threader (virtuosa 160 only)
- 9 Thread regulator
- 10 Thread slit
- 11 Thread take-up
- 12 Tension adjustment wheel
- 13 Bobbin pre-tension
- 14 Quick reverse button
- 15 Screen
- 16 Bobbin winder with on/off switch and thread cutter
- 17 Stitch width
- 18 Needle position
- 19 Stitch length
- 20 Continuous reverse
- Stitch counter buttonhole selector
- 21 Securing function
- 22 1/2 speed
- 23 clr button
- 24 Mirror image
- 25 Pattern end
- 26 Needle stop up-down
- 27 mem
- 28 Alphabet
- 29 Stitch selection
- 30 Stitch group selection
- 31 CPS – Customized Pattern Selection
- 32 FHS Presser foot lifter fixation hole
- 33 Handwheel
- 34 Balance
- 35 On/off power switch
- 36 Plug socket
- 37 Drop feed dog
- 38 Foot control socket
- 39 Presser foot lifter
- 40 Carrying handle
- 41 Spool pins
- 42 Sewing table socket
- 43 Thread cutter
- 44 Presser foot pressure

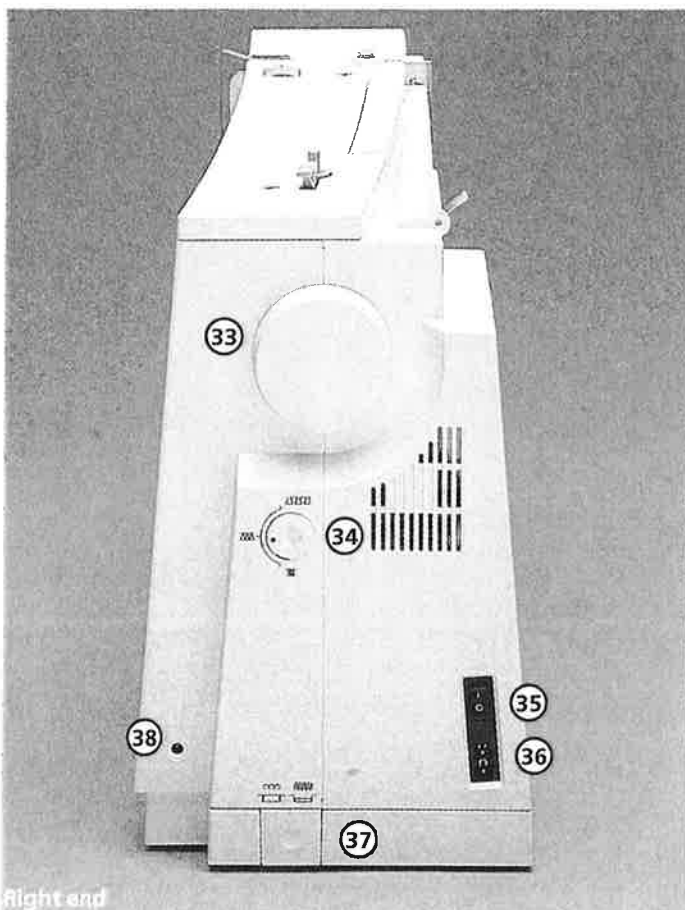

Carrying case

6

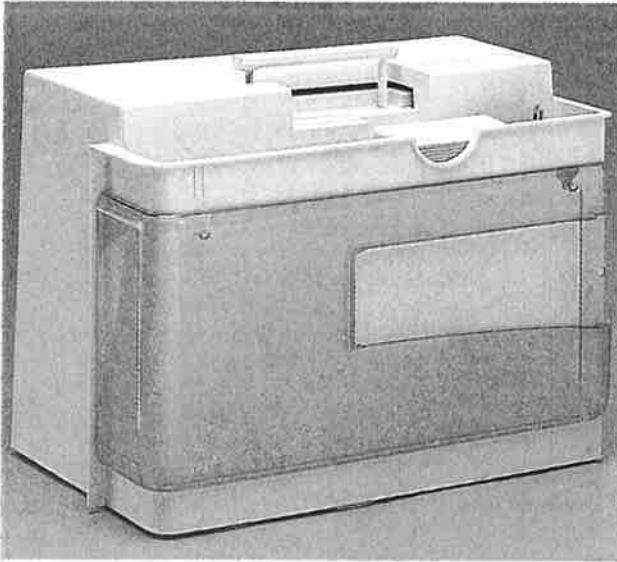

Carrying case

- protects machine from dust and dirt
- compartment for accessories

Accessories

- foot control
- instruction manual
- power cable
- warranty card
- presser foot lifter (FHS)
- sewing table * (attached)
To remove the sewing table, lift slightly and remove.

* Available as special accessory for virtuosa 150 QE



To remove the case

- grasp both sides
- pull off vertically

Note:

The separate spool pin must be removed to put the case on.

Accessory box

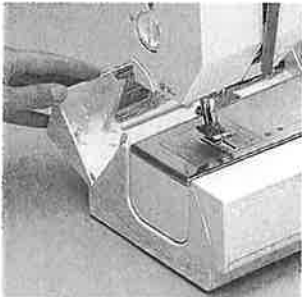

Enlarges the sewing surface

To open, lower the cover to the back



To remove

- pull the box to the left to work in free-arm mode

To attach

- push the box to the right until it engages

Note:

To remove the box, the hinged bobbin case cover on the free-arm must be closed.

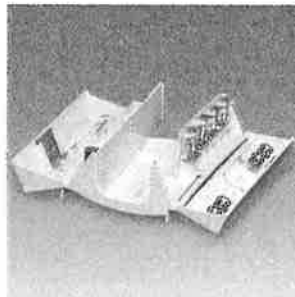

Standard accessories *:

- 5 bobbins
- Needle selection 130/705H
- Seam ripper
- Small screwdriver
- Special screwdriver
- Brush
- Seam guide
- Reverse feed foot #1
- Buttonhole foot #3
- Buttonhole foot with slide #3A**
- Zipper foot #4
- Blind stitch foot #5
- Patchwork foot #37
- Height compensating plates

Supplementary spool pin
3 spool discs
2 special BERNINA presser feet of your choosing

* can vary from country to country

** Available as special accessory for virtuosa 150 QE

Power cable

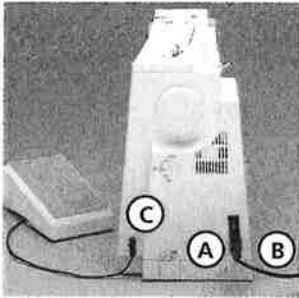

The **power cable** is stored in the case

- plug A into machine
- plug B into wall socket

Foot control cable

- plug C into machine

Important! (USA/Canada only)

This sewing machine has a polarized plug (one blade wider than the other). To reduce the risk of electric shock, this plug is intended to fit in a polarized outlet only one way. If the plug does not fit fully in the outlet, reverse the plug. If it still does not fit, contact a qualified electrician to install the proper outlet. Do not modify the plug in any way.

Foot control

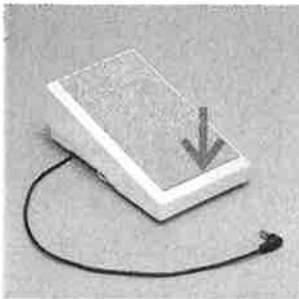

The **foot control regulates the sewing speed**

- raise or lower the needle by tapping on the foot control with your heel

Important!
(USA/Canada only)
Use only foot controller type LV1 or LV2 with sewing machines virtuosa 150/160.

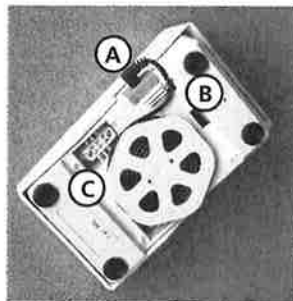

Self storing cord

- wind the cord on the reel
- insert the plug into A

When sewing

- slip the cable unwound to the desired length in B or C

Power switch

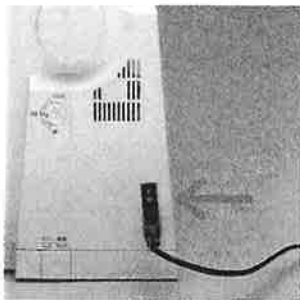

The switch is on the handwheel side of the machine

- **1** the machine is switched on
- **0** the machine is switched off

The sewing light is switched on and off with the power switch.

Refer to the safety instructions!

Sewing table*



Increases the sewing surface

To attach

- place over the free arm and press firmly so that it engages on the fixing cam

To remove

- pull to the left
- remove

Seam guide

- insert into the groove (underside of table) from the right
- it can be freely adjusted over the whole width of the table

Scale

- number «0» corresponds to the centre needle position

* Available as a special accessory for virtuosa 150

FHS (Free Hand System) presser foot lifter

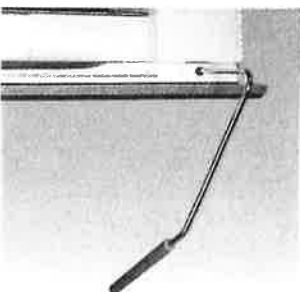

The **presser foot lifter raises and lowers the presser foot**

Push to the right

- the presser foot is raised
- the feed-dog is lowered simultaneously
- the feed-dog is raised as soon as the first stitch is sewn

Attaching the presser foot lifter

The presser foot lifter is stored in the case

- insert the presser foot lifter into the opening in the base plate

You should be able to operate the lifter with your knee in your normal sitting position

Note:

Your dealer can adjust it if necessary.

Winding the bobbin

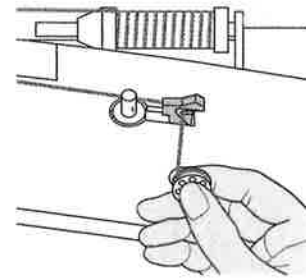
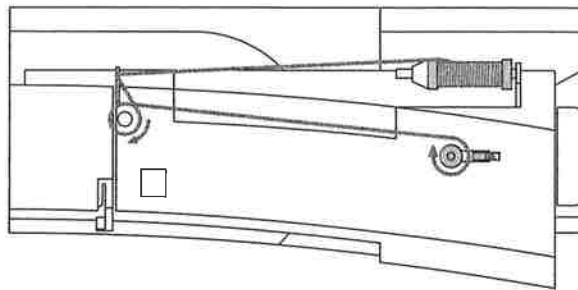
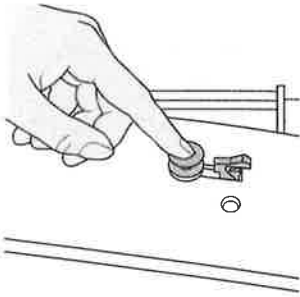

Winding the bobbin

- turn power switch on
- place empty bobbin on spindle
- following the direction of the arrow take thread through the rear guide and round the pre-tension stud
- wind it several times round the empty bobbin
- press the engaging lever against the bobbin
- press the foot control
- the motor will stop automatically when the bobbin is full
- remove the bobbin
- cut the thread on the thread cutter

Bobbin case

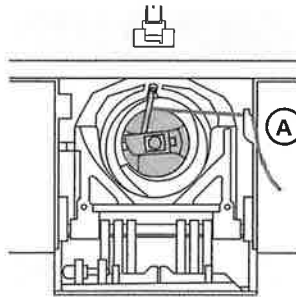
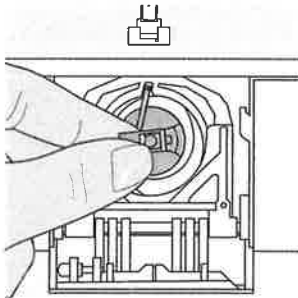
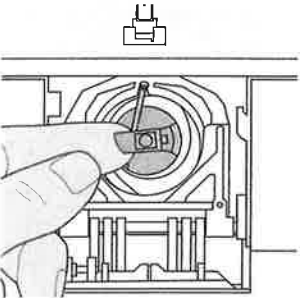

To remove

- raise the needle
- turn power switch to 0
- open the accessory box cover
- open the bobbin cover
- grasp the latch of the bobbin case
- remove case

To insert

- hold the bobbin case latch
- the finger on the case should point upwards
- insert so that it engages until it clicks
- close the bobbin cover
- close the accessory box cover

Bobbin thread cutter

- insert the bobbin case
- take the thread over the cutter A
- thread is cut

Refer to the safety instructions!

Note:

The bobbin thread does not have to be brought up as the loose end is just the right length to start sewing.

Inserting the bobbin

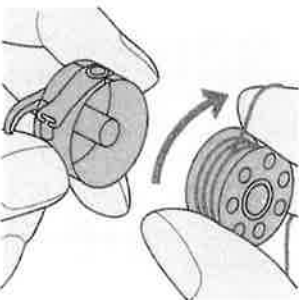

Insert the bobbin so that the thread runs clockwise.

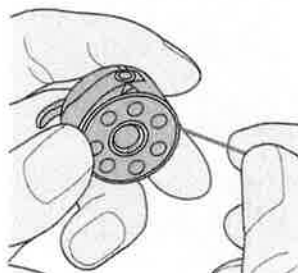

Pull the thread counter clockwise into the slot.



Pull the thread to the left under the spring until it lies in the T-shaped slit at the end of the spring.

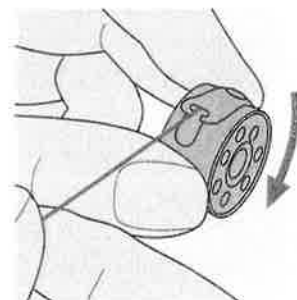

The bobbin must turn clockwise when thread is pulled.

Changing the needle

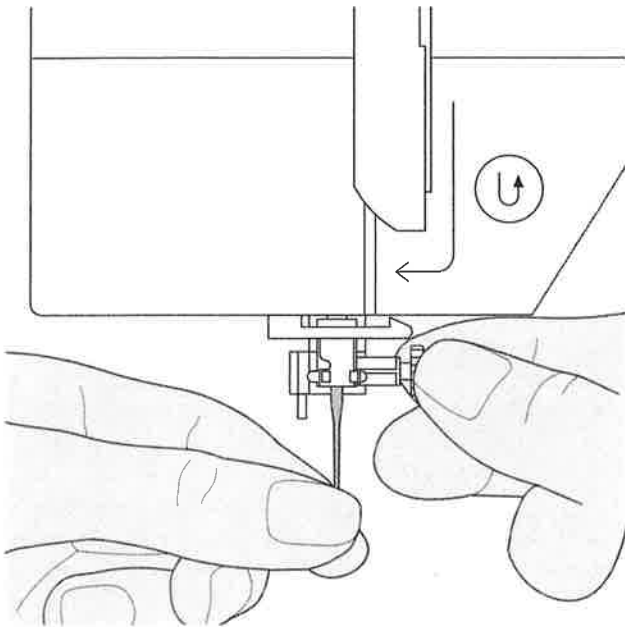

Removing the needle

- raise the needle
- turn power switch to 0
- remove the presser foot
- loosen the needle clamp screw
- pull the needle down to remove

Inserting the needle

- flat side of needle to the back
- insert the needle as far as it will go
- tighten the needle clamp

Refer to the safety instructions!

Changing the presser foot

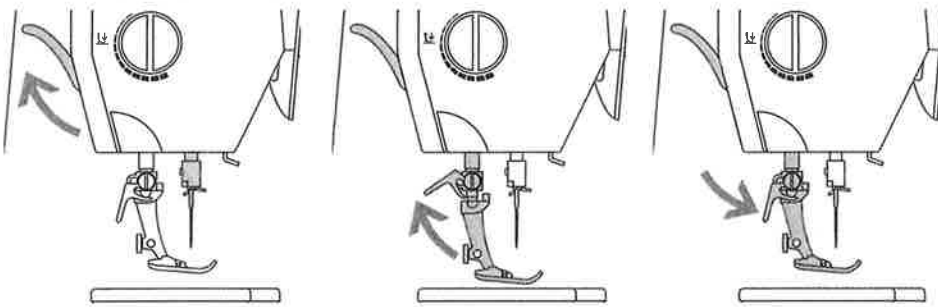

Presser foot with shank

- raise the needle and presser foot
- turn power switch to 0

- raise the clamping lever
- remove the presser foot

Attaching the presser foot

- guide the foot upwards over the cone
- press the clamping lever down

Refer to the safety instructions!

Supplementary spool pin

Vertical spool pin

- the supplementary (vertical) spool pin is stored with the accessories
- push it from right to left in the opening provided
- pull it to the right to remove
- essential when sewing with more than one thread, e.g. for double needle work

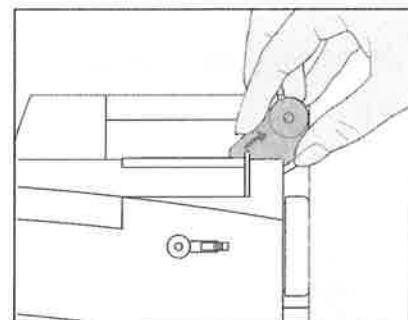
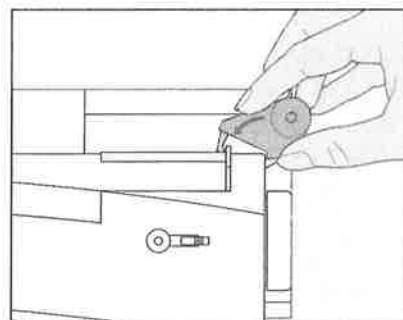

Threading the upper thread

10

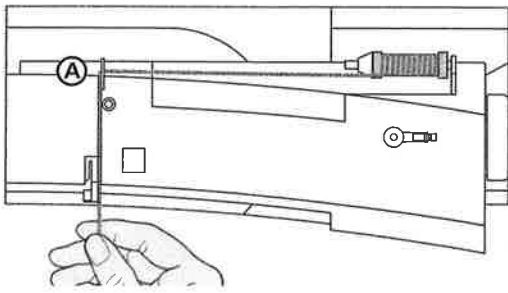

- raise the needle and presser foot
- turn the power switch to 0
- place spool on pin and attach the appropriate spool disc – diameter of spool = disc size
- take thread through rear guide A
- then into slit of upper thread tension
- pull thread down to the right of the take-up cover to B
- then up to the left of the cover to C
- and down through guides D and E

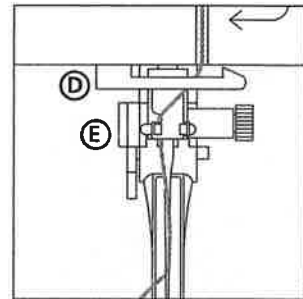
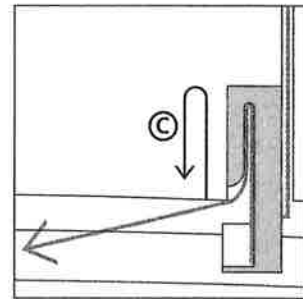
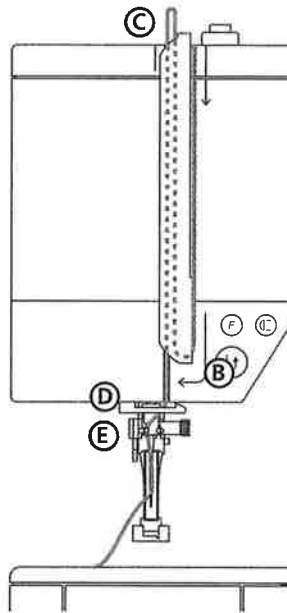

Refer to the safety instructions!

Needle threader (virtuosa 160 plus only)

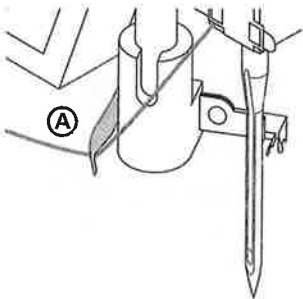

- lower the presser foot
- lay the thread behind hook A and hold lightly

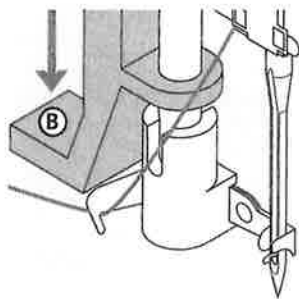

- press lever B down

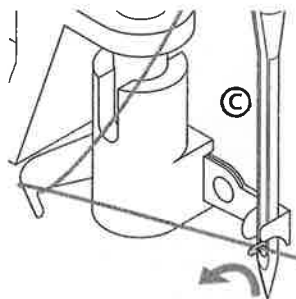

- take the thread in front of the needle C
- pass the thread from the bottom to the top of the needle until it catches in the hook

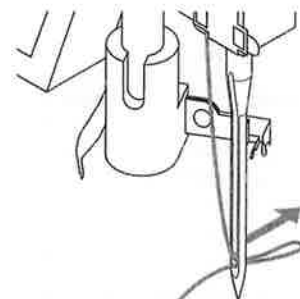

- let go of lever B and thread
- pull the thread loop through the needle eye

Bringing up the lower thread

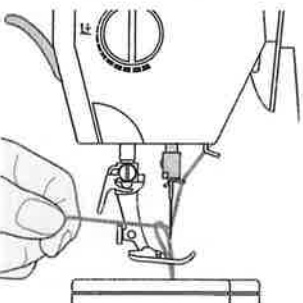

- hold the upper thread
- sew one stitch
- pull the upper thread until the bobbin thread appears in the stitch plate hole
- pull bobbin thread out of the hole and insert both threads through the slit in the presser foot towards the back
- pull threads over the cutter

Note:

The bobbin thread must be brought up through the stitch plate for certain types of work. The length of thread is sufficient for most normal work if the lower thread cutter has been used.

Thread cutter

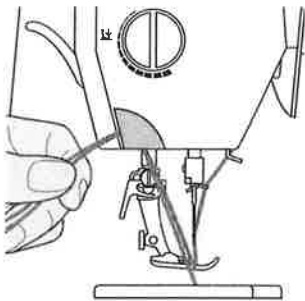

- pull both threads from front to back over the cutter
- the threads release as soon as the first stitch is sewn

Stitch plate

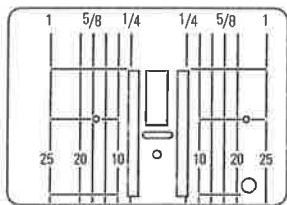

Stitch plate markings

- the stitch plate is marked with seam guide lines in mm and inches
- the millimetre markings are at the front
- the inch markings are at the back
- the measurements indicate the distance from the needle to the lines
- the needle insertion point is 0 (= needle position centre)
- lines are provided to the right and left of the needle
- they are very useful guide lines for precise seaming
- the horizontal lines are useful for buttonholes, etc.

Thread tension

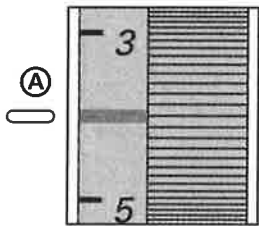

The basic setting

- is indicated when the red line on the tension adjustment wheel is in line with the marking A.
- the tension does not need adjusting for normal sewing work.
- for special sewing work, the tension can be adjusted to suit the fabric.

The tension can react differently when sewing with unusual threads and it is necessary to adjust the tension and select a needle which suits the thread.

For example:

	Tension	Needle
Metallic thread	approx. 3	90
Monofilament	approx. 2-4	80

To reduce the tension

- turn to between 3 and 1

To increase the tension

- turn to between 5 and 10

Feed-dog

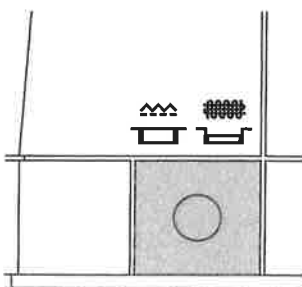

Button flush with base plate = sewing position

Button depressed = feed-dog is lowered
 · for free-hand sewing (darning, embroidery, etc.)

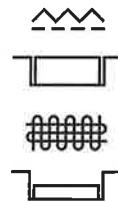

General instructions

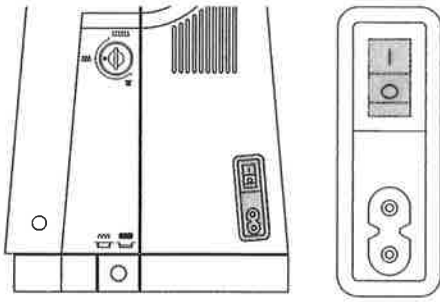

Main switch to 1

- the machine is ready to sew

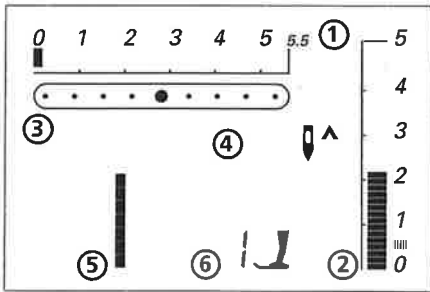

The screen shows

- 1 stitch width basic setting blinks constantly
- 2 stitch length basic setting blinks constantly
- 3 needle position (9 positions)
- 4 needle stop up/down (generally up)
- 5 stitch number 1 (straight stitch)
- 6 presser foot indicator (recommended foot for selected stitch)

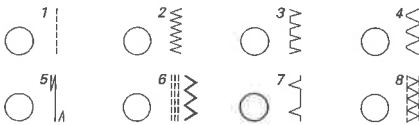

Stitch selection

- press the appropriate button – the number and basic stitch length and width settings appear on the screen



- These buttons are to select vertically arranged stitches



Stitch width

- left button = narrow the zig-zag
- right button = widen the zig-zag



Needle position

- left button = needle to the left
- right button = needle to the right



Stitch length

- left button = shorten the length
- right button = elongate the length



Needle stop adjustment

- press button = needle stop down
- machine stops with needle down (in fabric)
- press button = needle stop up



clr/del button

- deletes altered basic settings
- deletes selected functions

Exceptions:

- needle stop up/down
- altered basic settings for buttonhole
- 1/2 speed

Functions

Functions are **activated** when the symbol appears on the screen.
 Functions are **deactivated** when the symbols no longer appear on the screen.



Continuous reverse/stitch counter buttonhole selector

- machine sews permanently in reverse
- also serves as the stitch counter buttonhole selector when the buttonhole menu is open



Quick reverse

- press the button
- sews in reverse until the button is released
- programs buttonholes
- programs darning lengths
- switches to straight stitch securing program (stitch No. 5)
- manual securing beginning and end of seam



Securing function

- secures the beginning and ending of single stitches and stitch combinations

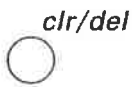

clr/del

- clears functions such as basic settings, stitch length, stitch width, needle positions, mirror image, single pattern
- Exceptions:** needle stop down, altered basic settings for buttonholes, 1/2 speed, continuous reverse

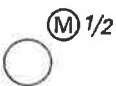

1/2 speed

- press the button and the sewing speed will be cut by half
- press the button again to revert to full sewing speed



Mirror image

- mirror image of selected stitch will be sewn



Stitch end

- machine stops at the end of a single stitch or stitch combination



Needle stop up/down

- machine stops with needle up
- press needle stop down button
- machine stops with needle down



mem (Memory)

- press the centre button to open memory (capacity of 30)
- use the left and mem+ buttons to scroll and programme stitches, letters and numbers

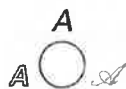

Altered stitch Memory

- any stitch length, stitch width or needle position alterations for all stitches will be saved automatically
- all stitches will be reverted to basic settings using clr/del
- all altered settings in Altered stitch Memory are lost when the machine is turned off

Letters, numbers

(block letters on virtuosa 150 QE)

- centre button
- select the letter style; the style selected will appear on the screen
- press the right button to scroll letters and numbers forwards A B C
- press the left button to scroll letters and numbers backwards 9 8 7

Letters/numbers/punctuation marks

**ABCDEFGHIJKLMN OPQRST
 UVWXYZ_ -.'!?() [] Ä Ö Ü Å
 Æ œ Ñ È É Ê Æ 0123456789**

Buttonholes

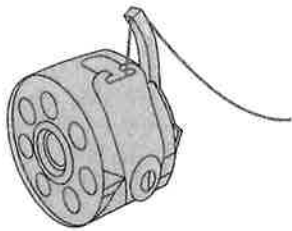

All buttonholes can be sewn in all styles.

Preparation

- thread the lower thread in the finger of the bobbin case
- use Buttonhole foot No. 3 or 3A

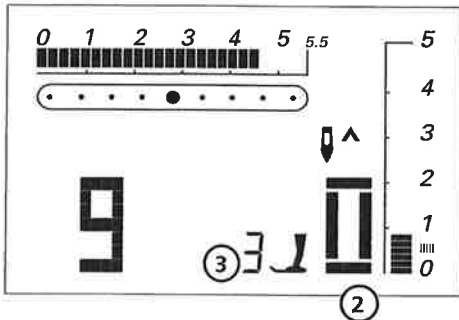

Buttonholes are not only practical closures, they can also be used to decorative effect

- No. 9 Standard buttonhole
- No. 10 Narrow standard buttonhole*
- No. 11 Stretch buttonhole*
- No. 12 Keyhole buttonhole
- No. 13 Straight stitch eyelet (*virtuosa 160 only)

Select the buttonhole of your choice, the following appears on the screen:

- 1 Buttonhole number
- 2 Buttonhole symbol
- 3 Presser foot number

Manual 4/6 step buttonhole (all types)

Manual buttonholes are particularly suitable for single buttonholes or for repairing existing buttonholes. Individual steps can be eliminated or repeated. The number of steps corresponds to the buttonhole type. Manual buttonholes cannot be saved.

Manual multiple-step standard and stretch buttonhole

Both beads are sewn in the same direction.

Preparation:

- Buttonhole foot No. 3
- insert the lower thread in the finger of the bobbin case

The individual steps blink on the screen

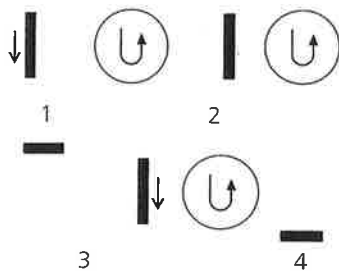

1. sew the first bead forward, stop the machine, press the quick reverse button
2. sew reverse straight stitch, stop the machine at the first stitch (buttonhole begin), press the quick reverse button
3. sew the top bar tack and the second bead, stop the machine, press the quick reverse button
4. sew the bottom bar tack and securing stitches

Manual multiple-step keyhole buttonhole

The individual steps blink on the screen.
Sew both forward and reverse beads at the same speed.

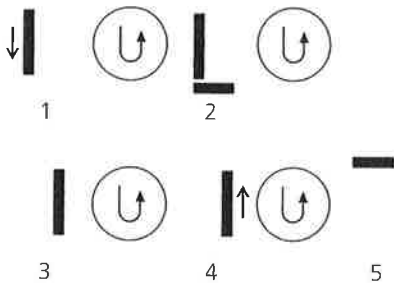

1. sew straight stitch forwards, stop the machine, press the quick reverse button
2. sew the eye and the first bead in reverse, stop the machine at the first stitch (buttonhole begin), press the quick reverse button
3. sew straight stitch forwards and stop at the keyhole, press the quick reverse button
4. sew the second bead in reverse, stop the machine at the first stitch (buttonhole begin), press the quick reverse button
5. sew bartack and securing stitches

See page 22 of the Sewing Manual for an example of a manual buttonhole.

Automatic standard and *stretch buttonholes with auto length

* virtuosa 160 plus only

(When sewing any type of automatic buttonhole, presser foot No. 3 is displayed at the beginning until programming the first bead length)

Both beads are sewn in the same direction.

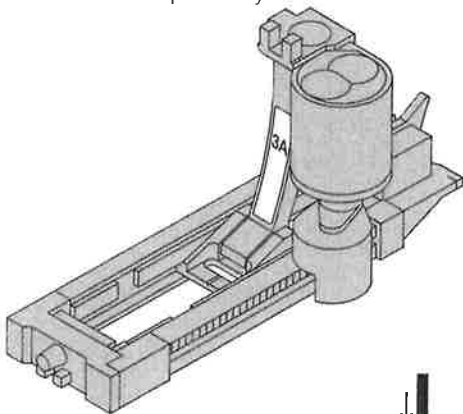

Automatic buttonhole

- when using Buttonhole foot 3A the length of the buttonhole is automatically registered by the lens on the foot
- the sewing sequence is indicated on the screen

The step currently being sewn blinks on the screen.

Programme the buttonhole

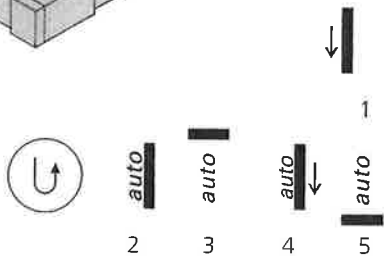

1. sew the first bead forwards, stop the machine
 - press the quick reverse button
 - auto and presser foot 3A are indicated on the screen = the buttonhole length is programmed
2. the machine sews reverse straight stitch automatically
3. the first bar tack
4. the second bead forwards
5. the second bar tack and securing stitches
 - machine stops and returns automatically to buttonhole begin

All subsequent buttonholes will be sewn to exactly the same length (no need to press the quick reverse button)

Press the clr/del button to delete the programme.

The programmed buttonhole can be saved in the long term memory (see page 18)

Compensating plates for buttonholes (special accessory)

If a buttonhole is to be sewn horizontally to the edge of the garment, it is worth using the compensating plates.

This accessory provides an even surface for the buttonhole foot with slide which results in a perfect buttonhole (see Sewing Manual tips page 21).

(Buttonhole foot 3A is available as a special accessory for virtuosa 150 QE)

Automatic keyhole buttonhole

16

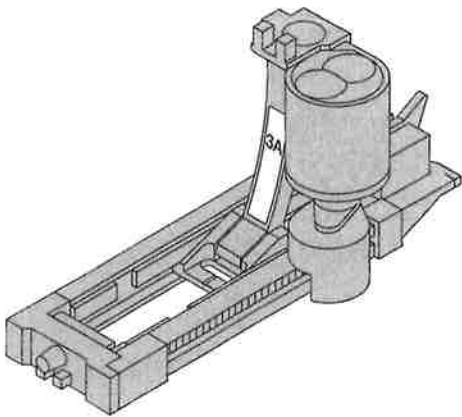

Both beads are sewn in the same direction.

Automatic keyhole buttonhole

- when using Buttonhole foot 3A the length of the buttonhole is automatically registered by the lens on the foot

Marking the buttonhole

Mark the bead length only. The correct eye length will be added when the buttonhole is sewn. The sewing sequence is indicated on the screen.

The step currently being sewn blinks on the screen.

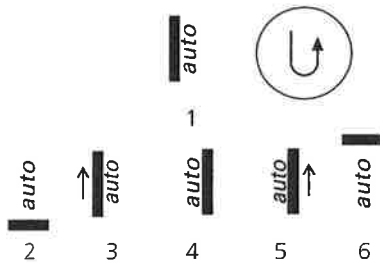

Programming the buttonhole

1. sew the straight stitch forward, stop the machine,
 - press the quick reverse button
 - auto and presser foot 3A are displayed on the screen
 - = buttonhole length is programmed
2. the machine automatically sews the eye
3. the first bead in reverse
4. sews second straight stitch
5. sews second bead in reverse
6. sews bartack and securing stitches
 - the machine stops and returns automatically to buttonhole begin
 - all subsequent buttonholes will be sewn to exactly the same length (without pressing the quick reverse button)

Press the clr/del button to delete the programme. The programmed buttonhole can be saved in the long term memory (see page 18).

(Buttonhole foot 3A is available as a special accessory for virtuosa 150 QE)

See page 24 of the Sewing Manual for an example of the automatic keyhole buttonhole.

Stitch counter buttonholes (all types)

The first bead is sewn forwards, the second bead in reverse. Sew forward and reverse beads at the same speed.

Preparation:

- Buttonhole foot No. 3 or Automatic foot 3A
- insert the lower thread into the finger of the bobbin case

Always test sew buttonholes

- test on the fabric and stabilizer you intend to use
- sew buttonholes in the same grain direction (with or against)

Programmed buttonholes on other fabrics

- the appearance of a programmed stitch counter buttonhole can vary depending on the fabric
- program on the fabric you intend to use

Corrections

- the buttonhole must be reprogrammed after altering the stitch length, width or balance
- test sew on the fabric you intend to use

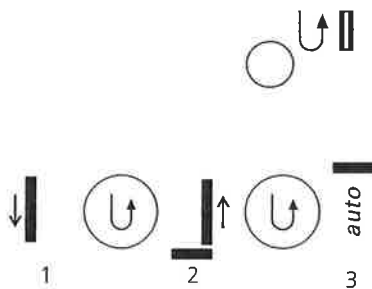

Select buttonhole

- press the reverse sewing button with the buttonhole symbol to select stitch counter buttonholes
- auto and presser foot No. 3 blinks on screen

The step currently being sewn blinks on the screen

1. sew the first bead forwards and stop the machine
 - press the quick reverse button
2. sew the bottom bartack or eye and the second bead in reverse
 - stop the machine at the first stitch (buttonhole begin)
 - press the quick reverse button
3. sew the top bartack and securing stitches
 - the machine stops automatically
 - «auto» appears on the screen = the buttonhole is programmed
 - all subsequent buttonholes will be sewn to exactly the same length without interruption and the machine stops automatically at the end of each buttonhole

Press the clr/del button to delete the programme

Note:

Stitch counter buttonhole cannot be saved in the long term memory

Examples of stitch counter buttonholes can be found on page 25 of the Sewing Manual

9

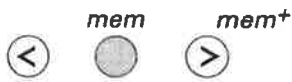

Saving programmed buttonholes in long term memory

- after programming press the mem⁺-button
- the buttonhole is now saved in long term memory
- stitch counter buttonholes cannot be saved in long term memory

Opening saved buttonholes

Programmed saved buttonholes can be opened for re-use even after the machine has been disconnected.

- select the buttonhole
- press the mem button
- sew the programmed buttonhole
- only one of any style buttonhole can be saved, if a new length is saved with mem⁺, it overwrites the previously saved buttonhole

The automatic darning program can be saved and opened in the same way as programmed buttonholes.

Altering buttonholes

- alterations to the stitch length and width affect both beads
- after altering the stitch length, program the buttonhole again
- altered stitch length/widths can be deleted by pressing the clr/del button

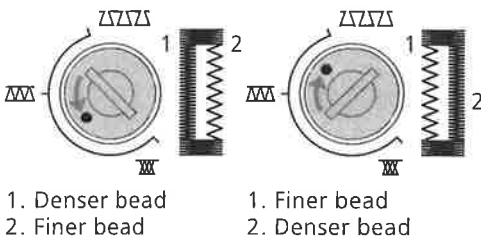

1. Denser bead
2. Finer bead

1. Finer bead
2. Denser bead

Balance

- any changes to the balance affect both beads of manual and auto length buttonholes because both beads are sewn in the same direction
- any distortions to keyhole buttonholes can be corrected with balance
- changes to the balance of stitch counter buttonholes affect the beads as shown in the illustration
- balance affects the individual beads and the eye

When altering the bead density with balance, delete the programmed buttonhole with clr/del.
Re-program with altered balance settings.

Note:

When all buttonholes have been sewn, return balance to the normal setting

18

Memory

Any combination of 30 stitches, letters or numbers can be saved in Memory, which is long term. They remain saved until deleted by the user. Power failures or disconnection from the electricity supply do not affect the Memory. Alterations to the stitch length, width or needle position can be made at any time. Individual stitches, letters or numbers can be deleted or overwritten.

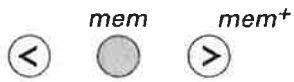

Memory – User buttons

- use the left button to scroll the contents backwards
- use the centre button to open and close the memory
- use the right mem+ button to save and forward scroll

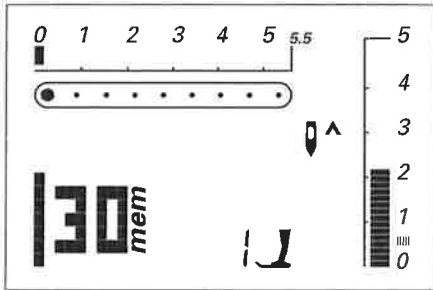

Screen display

- press the mem button
- memory is open, mem is displayed
- the cursor appears to the left and the number – «30» in our example – of the empty memory bank blinks

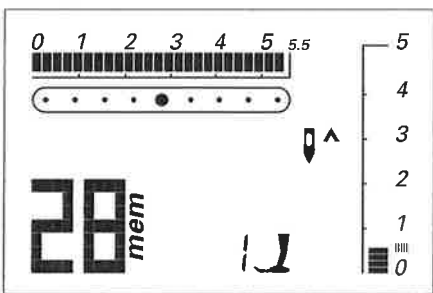

Stitches selected

- are indicated with numbers

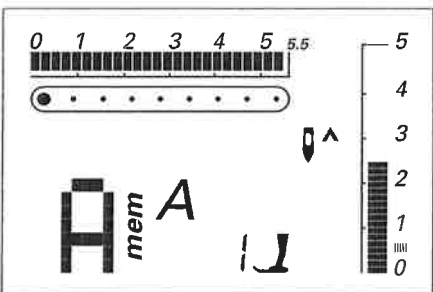

Letters and numbers

- indicated to the right of the word mem
- block (150 and 160)
- double block (160 only)
- italics (160 only)

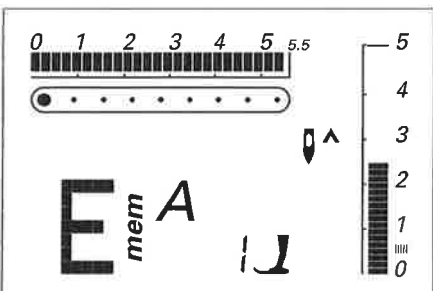

- the selected letter/number appears, e.g. E

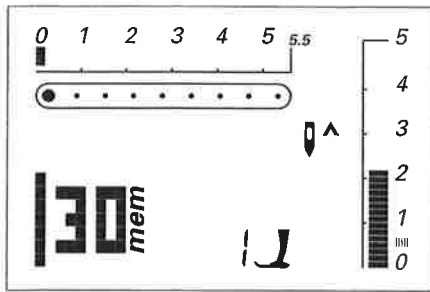

Programming practical and decorative stitches

Open memory

- press the mem button
- the cursor appears to the left, the number of available memory spaces (30) blinks and the word mem appears

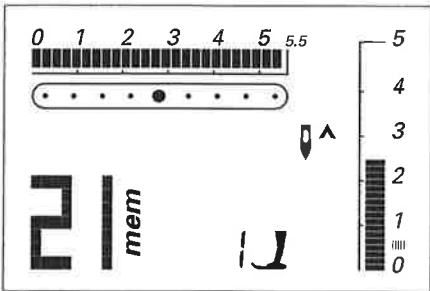

- select a stitch, e.g. 21
- stitch number appears on the screen



- press the mem+ (save) button
- the stitch is programmed

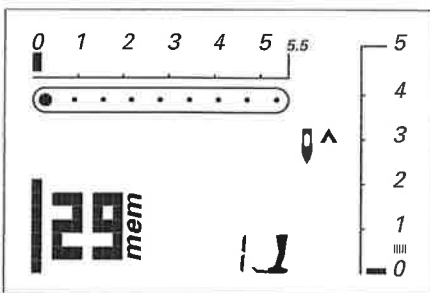

- the number of available memory spaces appears (cursor and memory spaces blink)

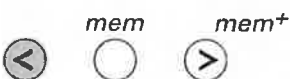

- select the next stitch
- press the mem+ button to save
- continue in the same manner



Scroll backwards

- press the left button
- the programmed stitches are scrolled backwards

Scroll forwards

- press the mem+ button
- the programmed stitches are scrolled forwards

Sew begin

When the foot control is pressed, the machine starts sewing the pattern combination. If the Pattern End function is selected, the sewing machine stops at the end of the pattern combination.

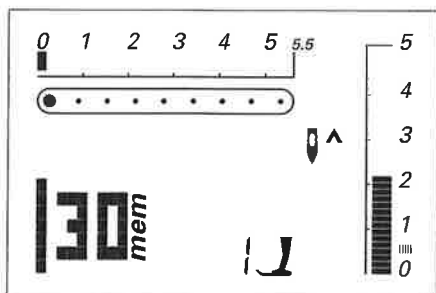

Programming letters and numbers

Open memory

- press the mem button
- the cursor appears to the left, the number of available memory spaces (30) blinks and the word mem appears



Delete complete memory contents

- press the clr/del button, keep depressed and press the mem button
- release both buttons
- leave memory by pressing mem button again
- memory is now cleared



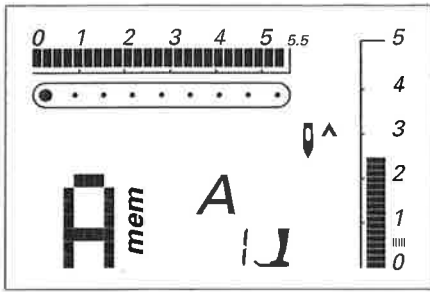

Select letter style

- press the alphabet button until the style you want appears on the screen
- the letter A in the style of your choice appears on the screen

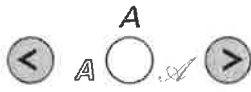

Selecting letters/numbers

- press the right button
- the letters A-Z appear
- press the left button
- the numbers 0-9 appear

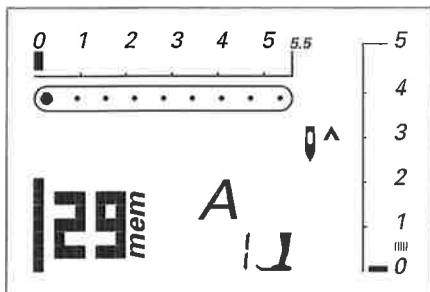

Programming letters/numbers

- select letter/number
- press mem+ (save) button
- letter/number is programmed
- the number of empty memory spaces is indicated (number and cursor blink)
- select the next letter/number
- press mem+ button and continue
- programming several words
- to insert a space, select (_) and save
- programme the next word
- if adjustments are made to the stitch length or width, all programmed letters will be affected
- if only single letters or numbers are to be altered, each must be altered individually

Corrections in memory

Overwriting stitches, letters or numbers

- press the mem+ or left button and scroll to the stitch you wish to overwrite

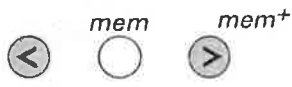

- select the new character
- press mem+ button to save
- the original stitch is replaced (overwritten) by the new one

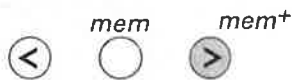

Deleting stitches, letters or numbers

- press the mem button and scroll to the stitch you wish to delete
- press the clr/del button
- the stitch is deleted



Leave memory

- press the mem button
- all entries are saved and memory closes

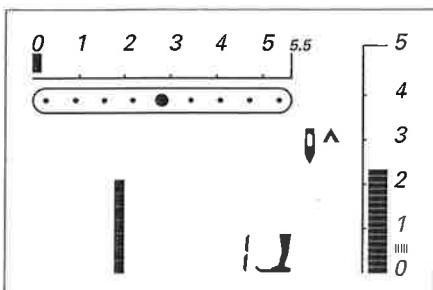
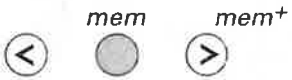

The word mem disappears from the screen

The contents of the memory remain saved even when the machine is disconnected from the electricity supply. They can be recalled at any time.

The contents of the memory will be lost if the sewing machine is switched off without pressing the mem button before closing the memory.

Additional information is provided in the Sewing Manual (page 8, 9).

Balance

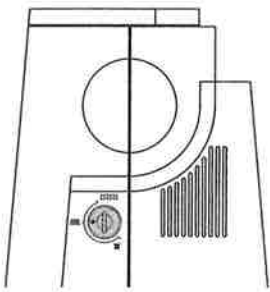

Balance
For balancing forward and reverse sewn stitches and for fine stitch length adjustments.

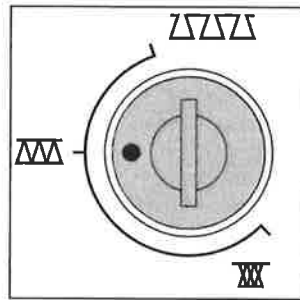

Normal position

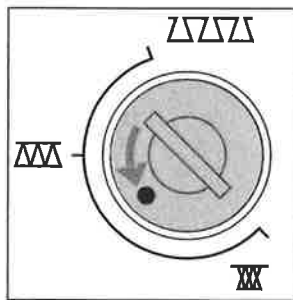

Denser stitch formation
(shorter stitch length)

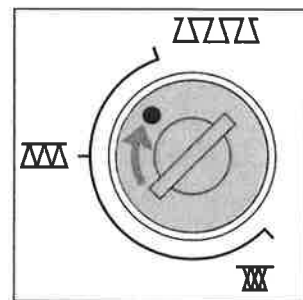

Finer stitch formation
(longer stitch length)

Note:
If the balance has been adjusted, return it to the normal setting once sewing is completed.

Applications:
Practical stitches, e.g. Honeycomb stitch on jersey, decorative stitches, fantasy stitches, letters, button-holes, etc.

Presser foot pressure

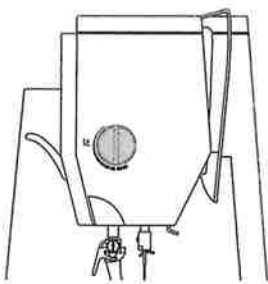

Pressure adjustment left end of machine

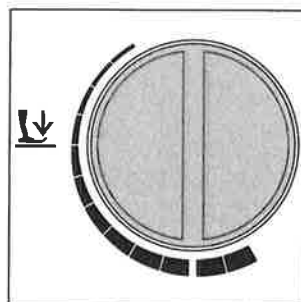

Standard pressure
· for normal sewing work

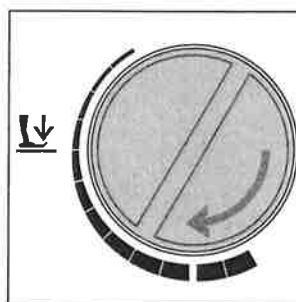

Reduced pressure
· for jerseys and loose knits
· to prevent fabric stretching
· adjust pressure so that the fabric still feeds correctly

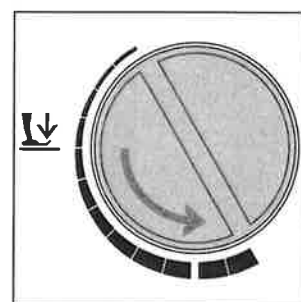

Increased pressure
· slippery, light weight fabrics
· improves fabric feed

Stitch selection

CPS (Customized Pattern Selection)

CPS allows you to replace pre-programmed stitches with others of your own choice from a selected range of practical and decorative stitches available from your **BERNINA** dealer.

virtuosa 150 QE =

12 replacement stitches

virtuosa 160 plus =

18 replacement stitches

virtuosa 150 QE practical and decorative stitches

- 1 Straight stitch
- 2 Zig-zag
- 3 Vari-overlock
- 4 Running stitch
- 5 Securing stitch
- 6 Triple straight and zig-zag
- 7 Blind stitch
- 8 Double overlock
- 9 Standard buttonhole
- 10 Keyhole buttonhole
- 11 Straight stitch eyelet
- 12 Darning program
- 13 Super stretch stitch
- 14 Honeycomb stitch
- 15 Jersey stitch
- 16 Stretch overlock

17-28 Replacement practical and decorative stitches (CPS)

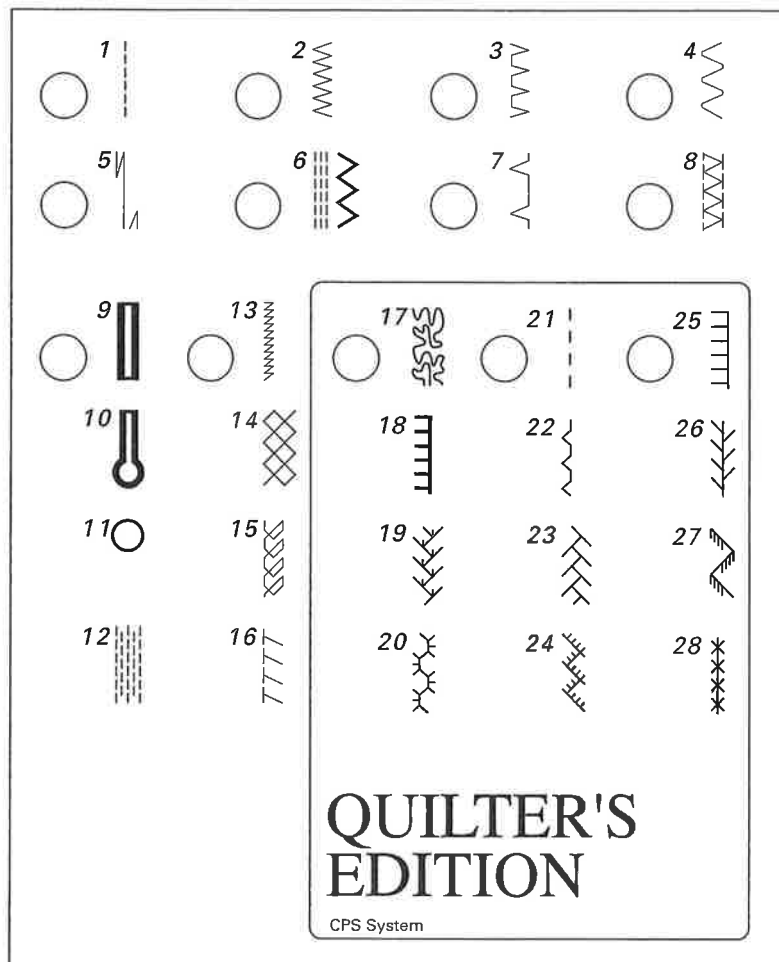

virtuosa 160 plus practical and decorative stitches

- 1 Straight stitch
- 2 Zig-zag
- 3 Vari-overlock
- 4 Running stitch
- 5 Securing stitch
- 6 Triple straight and zig-zag
- 7 Blind stitch
- 8 Double overlock
- 9 Standard buttonhole
- 10 Standard buttonhole narrow
- 11 Stretch buttonhole
- 12 Keyhole buttonhole
- 13 Straight stitch eyelet
- 14 Darning program
- 15 Super stretch stitch
- 16 Honeycomb stitch
- 17 Jersey stitch
- 18 Stretch overlock
- 19 Universal stitch
- 20 Gathering stitch

21-38 Replacement practical and decorative stitches (CPS)

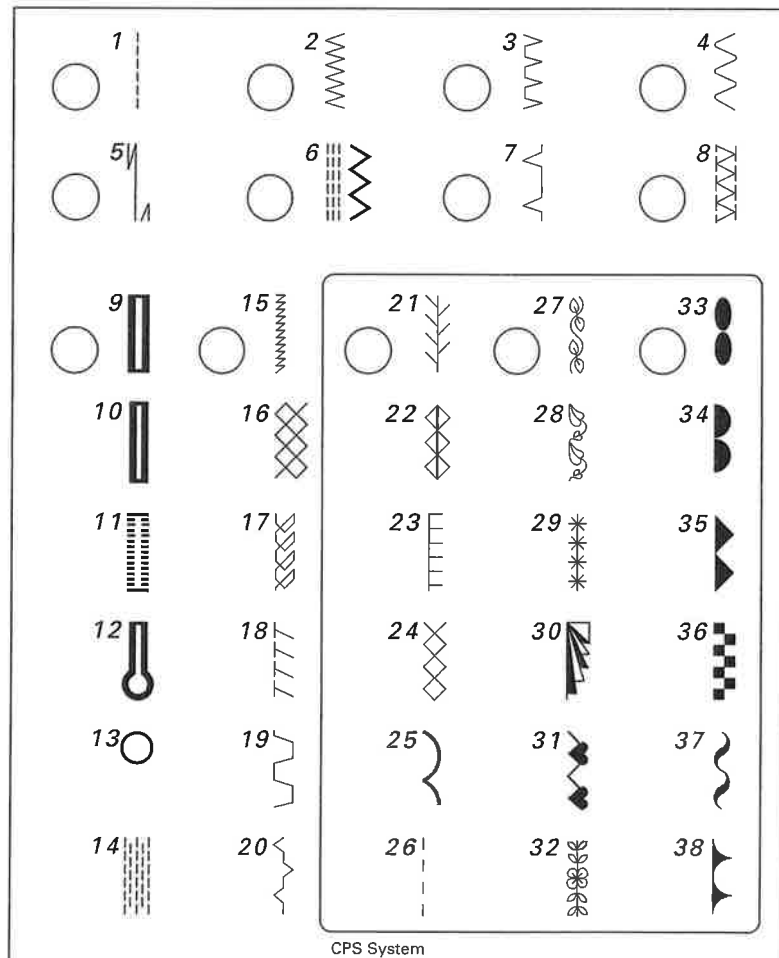

Stitch selection **virtuosa 150 QE**



1 Straight stitch All non-stretch fabrics. All straight stitch work.

2 Zig-zag Most fabric types. All simple zig-zag such as oversewing fine fabrics. Sewing on elastic and lace.

3 Vari-overlock Primarily for fine jerseys, stretch overlock seams and hems.



4 Running stitch Most types of fabric. Mending, patching, reinforcing seams.

5 Securing stitch All types of fabric. Secures the beginning and end of seams sewn with straight stitch.

6 Triple straight and triple zig-zag Reinforced seams in tough, heavy fabrics.



7 Blind stitch Most types of fabric. Blind hems, shell edging on soft jerseys and fine fabrics, decorative seams.

8 Double overlock All types of knit. Overlock = sew and neaten in one operation.

13 Super stretch Open seam for all super-stretch fabrics.



14 Honeycomb stitch Most types of interlock and smooth fabrics. Visible seams and hems.

15 Jersey stitch Natural, blended or synthetic fabrics and delicate knits. Visible seams and hems. Mending jersey/interlock.

16 Stretch overlock Medium weight knits, towelling and firm wovens. Overlock seams, flat joining seams.



12 Darning program Automatic darning for fine and medium weight fabrics.







9 Standard buttonhole Fine to medium weight woven fabrics. Blouses, shirts, trousers, bedlinens, etc.

10 Keyhole buttonhole Heavy weight, non stretch fabrics. Jackets, coats, trousers, leisure wear, etc.

11 Straight stitch eyelet Opening for cords and narrow ribbons.

Stitch selection *virtuosa 160 plus*

			1 Straight stitch	All non-stretch fabrics. All straight stitch work.
			2 Zig-zag	Most fabric types. All simple zig-zag such as oversewing fine fabrics. Sewing on elastic and lace.
			3 Vari-overlock	Primarily for fine jerseys, stretch overlock seams and hems.
			4 Running stitch	Most types of fabric. Mending, patching, reinforcing seams.
			5 Securing stitch	All types of fabric. Secures the beginning and end of seams sewn with straight stitch.
			6 Triple straight and triple zig-zag	Reinforced seams in tough, heavy fabrics.
			7 Blind stitch	Most types of fabric. Blind hems, shell edging on soft jerseys and fine fabrics, decorative seams.
			8 Double overlock	All types of knit. Overlock = sew and neaten in one operation.
			15 Super stretch	Open seam for all super-stretch fabrics.
			16 Honeycomb stitch	Most types of interlock and smooth fabrics. Visible seams and hems.
			17 Jersey stitch	Natural, blended or synthetic fabrics and delicate knits. Visible seams and hems. Mending jersey/interlock.
			18 Stretch overlock	Medium weight knits, towelling and firm wovens. Overlock seams, flat joining seams.
			19 Universal stitch	Firm fabrics such as felt and leather. Flat joining seams, visible seams, sewing on elastic, decorative seams.
			20 Gathering stitch	Most types of fabric. Gathering with shirring elastic. Butted seams = butting two pressed edges and sewing together.
			14 Darning program	Automatic darning for fine and medium weight fabrics.

			9 Standard buttonhole	Fine to medium weight fabrics. Blouses, shirts, trousers, bedlinens, etc.
			10 Standard buttonhole narrow	Fine to medium weight fabrics. Blouses, shirts, dresses, trousers, children's and baby clothes.
			11 Stretch buttonhole	All stretch fabrics made from cotton, wool silk and synthetic fibres.
			12 Keyhole buttonhole	Heavy weight, non stretch fabrics. Jackets, coats, trousers, leisure wear, etc.
			13 Straight stitch eyelet	Opening for cords and narrow ribbons.

Presser foot selection



1 Reverse pattern foot
Practical and decorative stitches



3 Buttonhole foot
Buttonholes



4 Zipper foot
Sewing in zips



5 Blind stitch foot
Blind hems, edge stitching

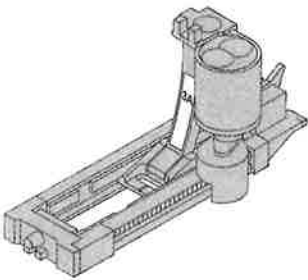

3A Buttonhole foot with slide
Buttonholes on smooth fabrics, darning (available as a special accessory for virtuosa 150 QE)



37 Patchwork foot
Patchwork with 1/4" seam allowance

BERNINA special presser feet (free choice)

The standard selection of presser feet covers most normal sewing requirements but we recommend the use of **BERNINA** purpose designed feet for special sewing tasks such as pintucking and darning.

As requirements vary, these presser feet are not included as standard. Instead you can select from a wide variety of special presser feet those that suit your particular sewing requirements. Ask your **BERNINA** dealer for details of the complete range.



0 Zig-zag foot



2 Overlock foot



6 Embroidery foot



8 Jeans foot



9 Darning foot



10 Edge Stitch foot



20 Open Embroidery foot



21 Cording foot



23 Appliqué foot

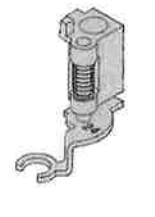

24 Freehand Embroidery foot

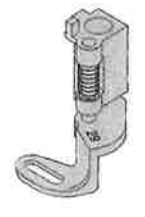

29 Freehand Embroidery foot (quilting)



31 5 groove Pintuck foot



32 7 groove Pintuck foot



68 Roll and Shell hemmer 2 mm



69 Roll and Shell hemmer 4 mm

Important facts about sewing machine needles

Sewing machine, needle and thread

Your **BERNINA** uses needle system 130/705H.

Needle and thread

The most commonly sold needles are nos. 70–120. The finer the needle, the lower the number. The table shows which needle is suitable for which threads. The needle you use depends on the thread. The needle must be suitable for the thread.

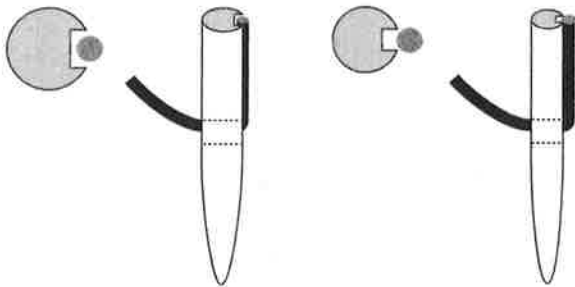

When sewing, the thread runs in the long groove on the needle.

If the needle is too fine, the groove will be too narrow for the thread and faulty stitching or thread breakage can occur.

Needle	70	80	90	100	110–120
Darning thread	<input type="radio"/>	<input type="radio"/>			
Embroidery thread		<input type="radio"/>			
Mercerised cotton thread		<input type="radio"/>	<input type="radio"/>		
Synthetic thread		<input type="radio"/>	<input type="radio"/>		
Thick threads, synthetic mercerised thread			<input type="radio"/>	<input type="radio"/>	
Buttonhole thread for decorative seams (cordonnet)				<input type="radio"/>	<input type="radio"/>

Needle and fabric Condition of needle

The needle must be in perfect condition. Problems can occur with damaged needles.

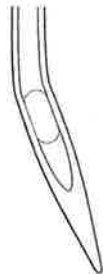

bent needle

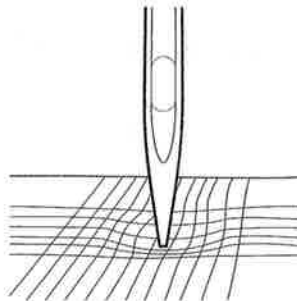



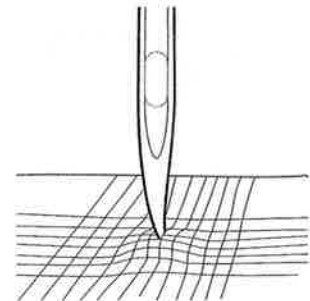



blunt needle

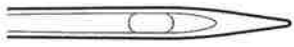
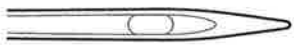

hooked needle

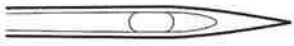
Important facts about sewing machine needles

Special materials are easier to sew if the appropriate needle is used. Special needles are available at your **BERNINA** dealer.

Needle table	Description	Needle point	Suitable for	
Standard needle	130/705 H	Normal point, slightly rounded	Universal needle for woven, synthetic and natural fibers, e.g. linen, chiffon, batiste, organdie, wool, satin, decorative stitching, embroidery	
Special needles	130/705-SES	Fine ball point	Fine knits, especially for synthetic fibers	
	130/705/H-SUK	Medium ball point	Heavier knits in synthetic or natural fibers	
	130/705 H-S	Medium ball point	Special needle for delicate or difficult stretch fabrics	
	130/705 H-J	Extra fine point	Overalls, heavy linen, denim, canvas. Pierces dense fabrics easily.	
	130/705 H-LR+H-LL	Cutting point	Natural and synthetic leather, plastic, coated and waxed fabric	
Double needle	130/705 H DO	Widths: 1,6 / 2,0 / 2,5 / 3,0 / 4,0	Visible hems in stretch fabrics, pintucks, decorative sewing	
Triple needle	130/705 H TRI	Widths: 2,5 / 3,0	Decorative sewing	
Hemstitch needle	130/705 H	Width: 2,0	Hemstitch in loose weaves	

Feed-dog and fabric feed

Feed-dog and stitch length

With each stitch the feed-dog moves forward by one step. The length of this step is determined by the stitch length selected. With an extremely short stitch length, the steps are also short. The fabric moves under the foot quite slowly, even at full sewing speed. Buttonholes, satin stitch and decorative stitches are all sewn with a very short stitch length.

Important



Let the fabric feed evenly!

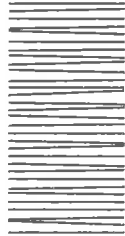

Pulling or pushing will result in gaps.



Holding back will result in knots.

Feed-dog and fabric feed

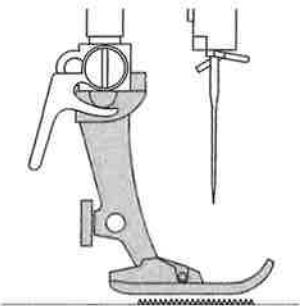

The feed-dog can work normally when the foot is level.

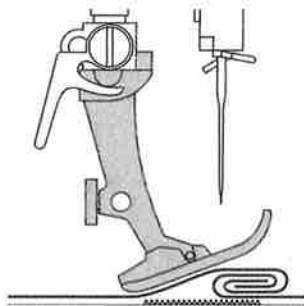

If the foot is at an angle, e.g. when sewing over thick to thin or vice-versa, the feed-dog cannot grip and feed the fabric and the fabric hangs up.

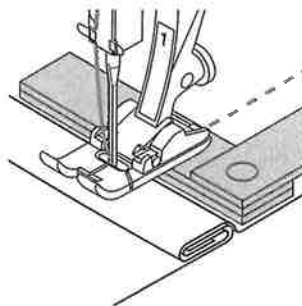

To solve this problem, place one, two or three compensating plates as required behind the needle under the presser foot.

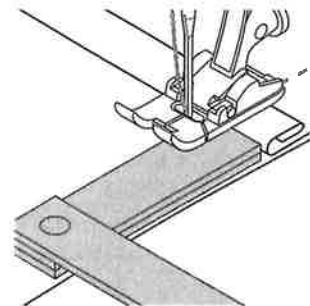

To correct the height in front of the foot, place one or more plates to the right of the foot close to the needle. Sew until the foot is level again and remove the plates.

Feed-dog and sewing corners

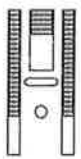

The gap between the two rows of teeth is relatively large due to the width of the stitch plate hole.

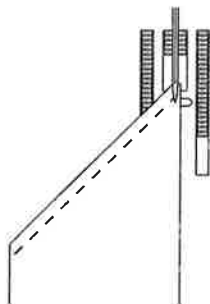

When sewing corners only a small section of the fabric is actually on the feed-dog so that it cannot grip the fabric well.

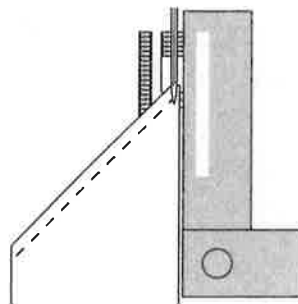

Correct this by placing one or more compensating plates as close as possible to the edge of the fabric.

Cleaning

If the machine is stored in a cold room, it should be brought to a warm room about one hour before use.

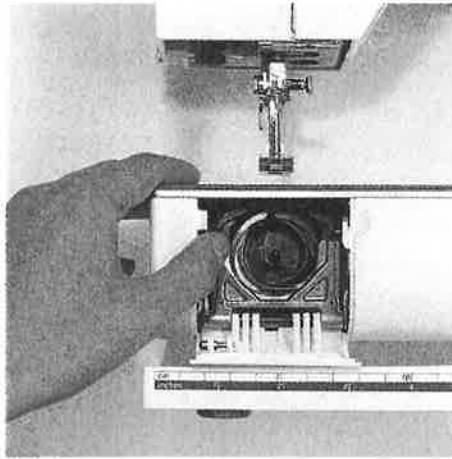
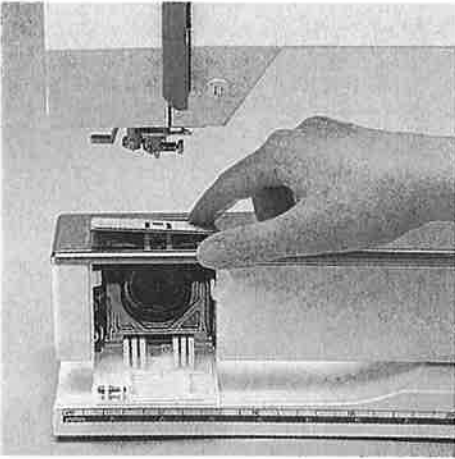

Important!
Never use solvents of any kind!

Cleaning

Clean the machine after every use

- turn power switch to 0
- remove presser foot and needle
- open the free-arm cover
- press the stitch plate down at back right corner
- lift and remove it
- clean the area with the brush
- replace the stitch plate

Cleaning the screen and the machine

- wipe with a damp cloth

Cleaning the hook

- turn power switch to 0
- remove the bobbin case
- push the release lever to the left
- push the locking lever to the left and fold down the hook race cover
- remove the hook
- clean the hook race with a cloth or brush, never use a sharp instrument
- replace the hook, turning the handwheel if necessary so that the hook driver is on the left
- close the hook race cover and secure with the locking lever, the locking pin must engage
- check by turning the handwheel
- insert the bobbin case

Lubricating

This machine is equipped with a LM (low mass) hook system which requires no lubrication. If however you do lubricate any parts, always run the machine immediately afterwards on scrap material to avoid soiling your work.

Sewing light

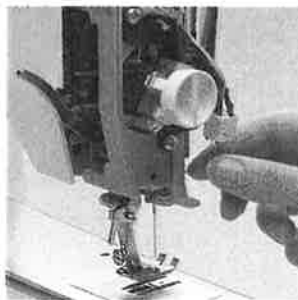
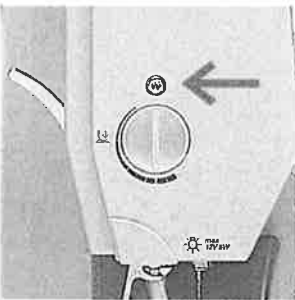

Note:
Use bulb type
12 V 5 W.
W 2.1 x 9.5 d.

Refer to the safety instructions!

Light bulbs get hot.
Allow to cool down before removal.

Replacing the bulb

- turn power switch to 0
- loosen the screw
- remove the cover
- remove the bulb
- insert the new bulb
- replace cover and tighten screw

Trouble shooting

In most cases you will be able to identify and remedy faults by checking the following.

Check whether:

- the upper and lower threads are threaded correctly
- the needle is inserted correctly with the flat side to the back
- the needle size is correct – check the needle/thread table
- the machine is clean – brush out any thread fluff
- the hook race is clean
- any threads are trapped between the tension discs or under the bobbin case spring

Upper thread breaks

- The upper thread tension is too tight.
- The needles are of a poor quality. Ideally needles should be purchased from your **BERNINA** dealer.
- The needle has been inserted incorrectly. The flat side of the shank must be to the back.
- The needle is bent or blunt.
- Poor quality, knotted or dried out thread has been used.
- Use the correct spool disc.
- Stitch plate or hook tip damaged. Take your machine to your **BERNINA** dealer.

Lower thread breaks

- The lower thread tension is too tight.
- The bobbin is jamming in the bobbin case. Remove and replace the bobbin.
- The hole in the stitch plate has been damaged by the needle. This must be repolished by an expert.
- The needle is blunt or bent.

Skipped stitches

- Wrong needles used. Use only 130/705H system.
- The needle is blunt, bent or incorrectly inserted. Push right to the top when inserting.
- Needle inserted all the way to the top.
- The needle point does not suit the fabric being sewn. If necessary use a ball point for knitted fabrics and cutting point for hard leather.

Needle breaks

- Needle clamp screw loose.
- Fabric taken out in front of instead of behind the presser foot.
- When sewing over thick area, the fabric was pushed with the needle still in the fabric.
- Poor quality thread, unevenly wound or knotted.

Faulty stitching

- Remnants of thread between the tension discs.
- Remnants of thread under the bobbin case spring.
- Lower thread still threaded in the bobbin case finger.
- Machine threaded with foot down.
- Incorrect threading. Check upper and lower threads.
- Use the correct spool disc.

Machine fails to run or runs slowly

- Plug not properly inserted.
- Power switch in off position.
- Machine has been standing in a cold room.
- Bobbin winder still switched on.

Machine sews in reverse

Reverse sewing function is still activated.

Index

A	F	N	S
Accessory box 6	Faults 31	Needle 10	Safety instructions 1
Alphabet 13	Feed Dogs 11	· threading 10	Securing button 13
Altered stitch memory 13	· and fabric feed 29	· and thread 27	Securing function 13
	· and presser foot 29	· information 28	Securing stitch 23, 24
	· and sewing corners 29	· changing 9	Sewing corners 29
	· and stitch length 29	Needle position 12	Sewing light 30
	· lowering 11	Needle stop up/down 12	Sewing table 7
	Foot control 7	Needle threader 10	Skipped stitches 27
	Free-Hand System 7	Numbers/lettering, programming 20/21	Speed (1/2) 13
	Functions 13		Standard buttonhole 14, 15, 17
			Stitch counter buttonhole selector 13
B	G	O	Stitch length 12
Balance 17	General operating instructions 12	Operating instruction 12	Stitch width 12
Bobbin case 8			Stitch plate markings 11
· inserting 8			Stitch selection 24, 25
Bobbin thread 31		P	Stretch buttonhole 14, 15, 17
· breaks 10		Pattern end 13	Supplementary spool pin 9
· bringing up 8		Personal memory 13	
· inserting 8		Power cable 7	T
· winding 8		Power switch 7	Tension 11
Bulb 30		Practical stitches 24, 25	Thread cutter 11
· changing 30	H	Presser feet 9	Thread tension 11
Buttonholes 15	Hook 30	· changing 9	Thread 27
· auto keyhole 15	· cleaning 30	· selection 26	· and needle chart 27
· auto standard 15		Presser foot display 12	· and needles 27
· auto stretch 14		Presser foot lifter 7	· bringing up the lower thread 10
· manual 4-step keyhole 14		Presser foot pressure 22	· tension 11
· manual 6-step standard 14		Programming memory 20, 21	· upper thread threading 10
· stitch counter 17	I		Threader 10
· balance 16, 17	Index 32		Trouble shooting 31
	Inserting a bobbin 8	Q	
		Quick reverse 13	
C	K		
Cable 7	Keyhole buttonhole 14, 16, 17	R	
Cable connection 7		Reverse sewing 13	
Carrying case 6		· continuous 13	
Cleaning 30			U
Clr/del button 13			Upper thread 25
Contents 3	L		· breaks 25
Continuous reverse 13	Lettering/number, programming 20/21		· threading 10
Corners 29			
CPS – Customized Stitch Selection 23			
	M		
D	Maintenance 30		
Decorative stitches 23	Memory programming 19–21		
Details of the machine 4, 5	Motor speed 13		
Double overlock 18, 19			

Sewing Manual

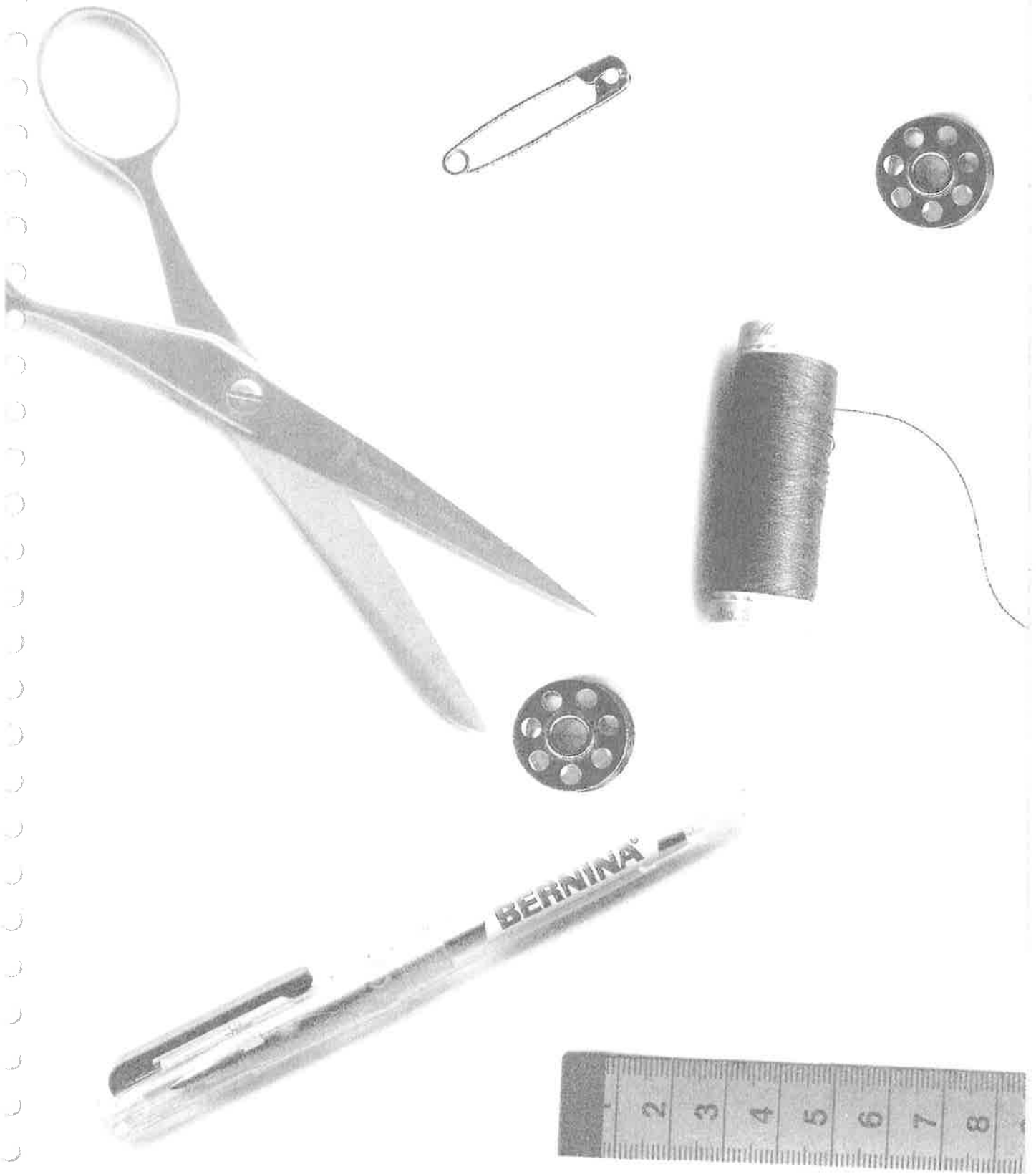

Straight stitch/zig-zag	2–5
Decorative stitches	6, 7
Memory	8, 9
Seams, hems with practical stitches	10–14
Sewing knits	15, 16
Zippers	17
Blind hem	18
Elastic	19, 20
Buttonholes/eyelets	21–27
Quilt stitch	28, 29
Darning/mending tears	30–34
Index	35

2 Straight stitch

Stitch: **Straight stitch No. 1**
 Needle: **size and type suitable for the fabric selected**
 Thread: **cotton or polyester**
 Feed-dog: **up (sewing position)**
 Presser foot: **Reverse pattern foot No. 1**

Straight stitch (A)

- The machine is ready to sew as soon as you switch on
- select straight stitch
 - presser foot display
 - basic settings (length and width) for straight stitch
 - basic settings blink constantly

Altering the stitch length (B)

You can alter the length while you sew:

- ⓪ shorten
- ⓐ lengthen

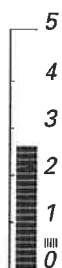

Change the needle position (C)

- ⓪ to the left
- ⓐ to the right

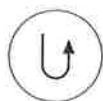

Securing with quick reverse button (frame)

- press the button and the machine sews in reverse
- release the button and the machine sews forward

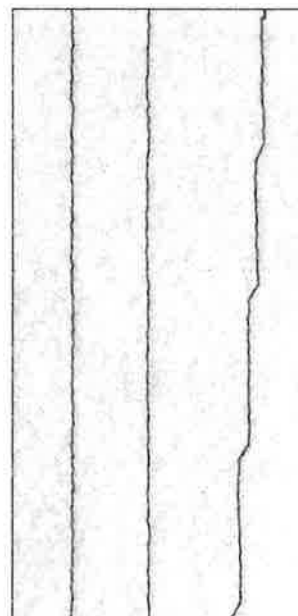

A B C

- A** – straight stitch with length of 2.25 mm preset length
- B** – straight stitch with altered stitch length
- C** – straight stitch with altered needle positions



TIPS

Adjust the stitch length to suit the fabric:

- e.g. use a longer stitch length (approximately 3 mm–4 mm) with denim, shorter length (2 mm–2.5 mm) with batiste

Adjust the stitch length to suit the thread:

- e.g. use a longer stitch length (approximately 3 mm–5 mm) when sewing with cordonnet thread for top stitching

Activate needle stop down

- prevents the fabric slipping when you stop to adjust it

Securing stitch (straight stitch)



Stitch: **Securing stitch No. 5**
 Needle: **size and type suitable for the fabric selected**
 Thread: **cotton or polyester**
 Feed-dog: **up (sewing position)**
 Presser foot: **Reverse pattern foot No. 1**

Securing stitch
 for all fabrics
 secures beginning and end of seam

Stitch selection
 · touch stitch No. 5

On-screen
 · presser foot
 · basic settings (width and length)

Sewing

Seam begin

- machine secures seam automatically (5 stitches forward, 5 stitches reverse)
- continue with straight stitch forward



Seam end

- press the quick reverse button
 machine secures automatically (5 stitches forward, 5 stitches reverse)
- machine stops automatically when securing is complete

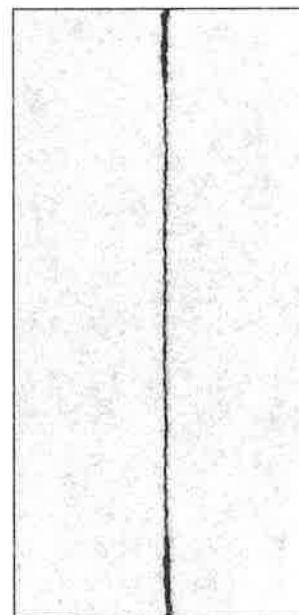

TIP

Sewing long seams

- quick and easy securing at beginning and end of seam

4 **Edge stitching**

Stitch: **Straight stitch No. 1**
 Needle: **size and type suitable for the fabric selected**
 Thread: **cotton, polyester or cordonné (topstitching)**
 Feed-dog: **up (sewing position)**
 Presser foot: **Reverse pattern foot No. 1 or Blind stitch foot No. 5**
Edge stitch foot No. 10 (optional)

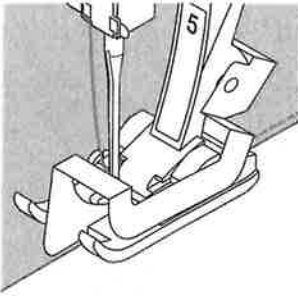
**Narrow edge stitching****Needle position**

- left for outer edge
- right for inner edge

Presser foot

- Blind stitch foot No. 5

Example**Outer edge**

- place edge of fold against the guide on the foot
- select needle position at desired distance from the edge

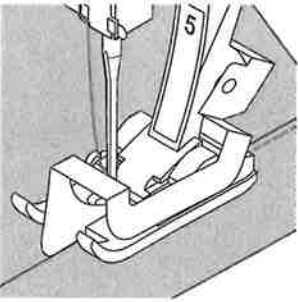
**Hem edges**

- place edge of fold against the guide on the foot
- select needle position right

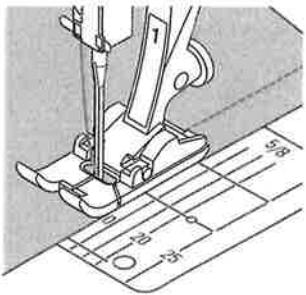
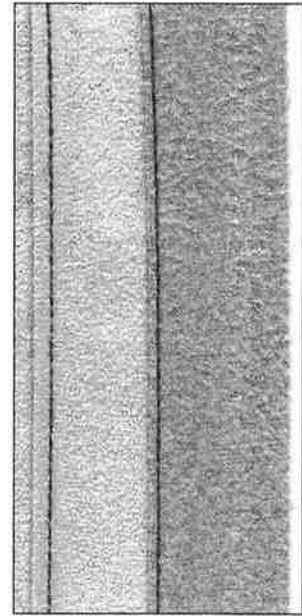
**Wide edge stitching****Needle position**

- all

Presser foot

- Reverse pattern foot No. 1

At a foot's width (A)

- guide the fold along the edge of the presser foot sole

At 1–3 cm (B)

- guide the folded edge along the markings on the stitch plate

Seam guide (C)

- insert the seam guide into the hole on the presser foot shaft
- adjust as desired
- guide the folded edge along the seam guide
- to sew parallel lines, guide the fabric along a previously sewn line of stitches

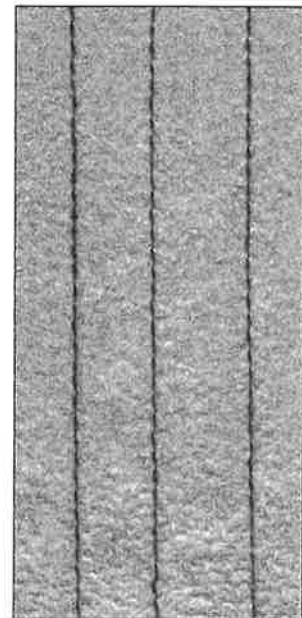
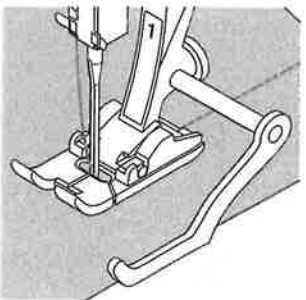

A B C

**TIP****Edge stitching with seam guide**

- a big help when sewing parallel lines

Zig-zag stitch



Stitch: **Zig-zag No. 2**
 Needle: **size and type suitable for the fabric selected**
 Thread: **cotton or polyester**
 Feed-dog: **up (sewing position)**
 Presser foot: **Reverse pattern foot No. 1**

Zig-zag stitch

for all fabrics
 for neatening edges
 for decorative work

Stitch selection

· press the appropriate button (zig-zag)

On-screen

· presser foot
 · basic settings (length and width)

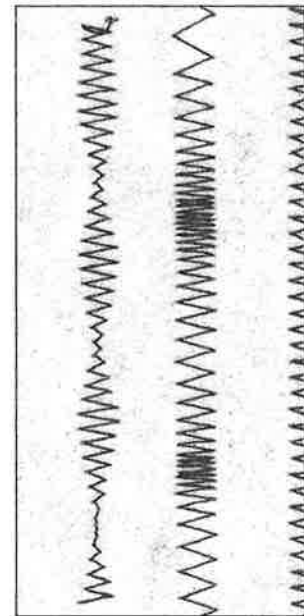

A **B** **C**

A – zigzag stitch with altered stitch width

B – zigzag stitch with altered stitch length

C – fabric edges finished with zigzag stitch



Altering the stitch width (A)

the width can be altered while you sew

⊕ wider
 ⊖ narrower



Altering the stitch length (B)

the length can be altered while you sew

⊕ shorter
 ⊖ longer

Satin stitch

dense (shorter) zig-zag stitch = filled in zig-zag

Oversewing edges (C)

· guide edge of fabric under the center of the presser foot
 · needle goes into fabric on one stroke and over the edge of the fabric on the next stroke
 · do not select too wide a width or too long a stitch – the edge should lie flat and not roll
 · use darning thread for fine fabrics



TIP

Oversewing edges with zig-zag

· if edges roll, use Vari-overlock stitch No. 3 and foot No. 2 (optional foot)

Embroidery with satin stitch

· adjust the stitch width as you sew for new effects

6 Decorative stitches

- Stitch: **Decorative stitch**
- Needle: **size and type suitable for the fabric selected**
- Thread: **cotton or rayon embroidery**
- Feed-dog: **up (sewing position)**
- Presser foot: **Reverse pattern foot No. 1 or No. 6 (depending on stitch)**

Decorative stitches
for all fabrics, for embellishing

Stitch selection
· press appropriate button

Altering the basic settings



Stitch width
⊕ wider
⊖ narrower



Stitch length
Ⓢ shorter
Ⓛ longer

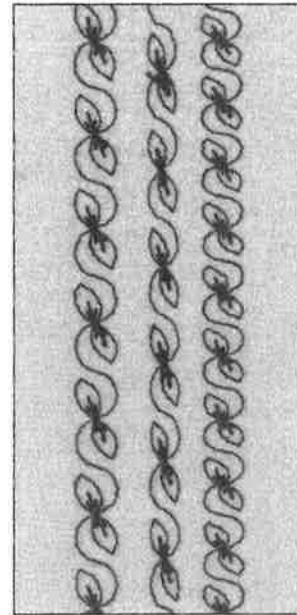

A C B

- A** – decorative stitch with preset width and length
- B** – decorative stitch with reduced width
- C** – decorative stitch with shortened length



TIP

Altering the basic settings

- stitches can be adjusted to suit your own tastes, e.g. for dolls clothes, reduce the width
- the size of motifs can be adjusted to suit small items

Decorative stitches on single layer of fabric:

- always use stabilizer underneath
- remove after sewing is complete

Combining decorative stitches with functions

Stitch: **Decorative stitches**
 Needle: **size and type suitable for the fabric selected**
 Thread: **cotton or rayon embroidery**
 Feed-dog: **up (sewing position)**
 Presser foot: **Reverse pattern foot No. 1, open Embroidery Foot No. 20 or Embroidery Foot No. 6 (optional)**

- every stitch can be combined with functions
- more than one function can be used with individual stitches
- press the clr/del button to delete the functions

Method



- select stitch (A)
- sew



- select function (e.g. mirror image) (B)
- sew



- select 2nd function (e.g. securing) (C)
- sew

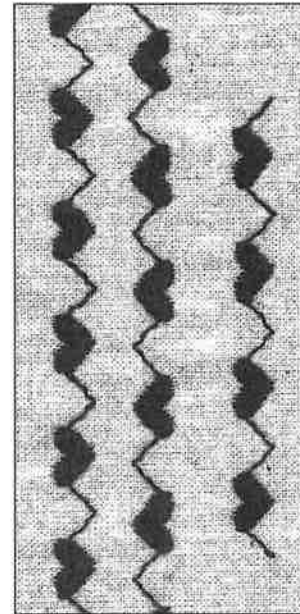

B A C

Deleting functions

- special functions – press the appropriate button to disengage or press the clr/del button.

Note:

use of the clr/del button will remove most functions and all stitch alterations

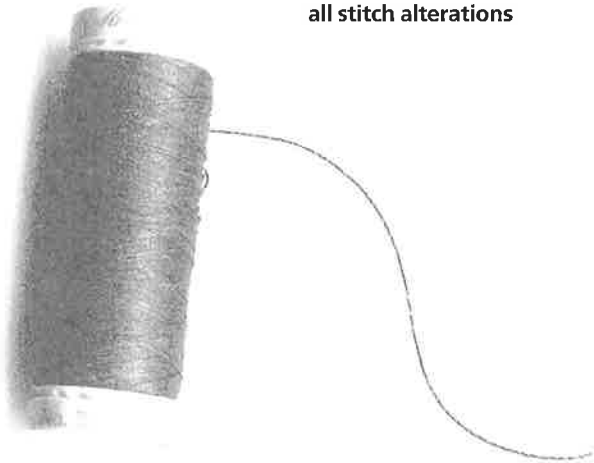

TIP

Activate needle stop down when sewing long seams

- prevents fabric slipping when stopping to adjust it

Activate pattern end function:

- machine stops after each stitch pattern

Decorative stitches on single layer of fabric:

- always use stabilizer underneath
- remove after sewing is complete

Practical and decorative stitches in Memory

- The memory can store up to 30 stitches
 - Every practical and decorative stitch can be saved in memory
 - Any combinations of practical and decorative stitches as well as letters and numbers can be saved in the memory
 - The memory contents remain saved even when the machine is disconnected from the electricity supply
 - Memory contents can be recalled at any time
- Exceptions: buttonholes, securing stitch No. 5, eyelet

Programming practical and decorative stitches
see instruction manual

Examples

- program a stitch combination of your choice in the memory (A) and
- sew repeatedly



- save a stitch combination
- activate mirror image
- save mirror image (B) and sew both repeatedly



- program a stitch combination of your choice in the memory
- activate pattern end (C)
- machine stops automatically at the end of the combination



- program a partially mirror imaged stitch in the memory
- activate pattern end (D)
- machine stops automatically at the end of the combination

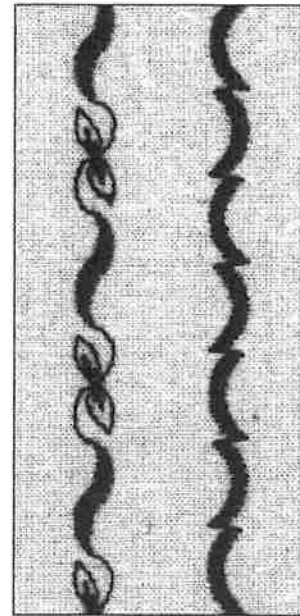

A

B



C

D



TIP

Decorative stitch combinations with embroidery thread

- gives stitches a fuller appearance

Stitch combinations on double fabric

- bottom layer does not pucker

Stitch combinations on single fabric

- always use stabilizer as a backing
- remove after sewing

Letters and numbers in memory

(Block letters on the virtuosa 150 QE)

- The memory has a capacity for 30 stitches.
- All letters can be programmed in memory.
- All letters and numbers as well as practical and decorative stitches can be combined at will and programmed in memory.
- The memory contents remain saved even when the machine is disconnected from the electricity supply.
- The memory contents can be recalled at any time.

Programming letter and numbers
see instruction manual



A B C

A

Examples

Program name in block capitals (A)

- activate pattern end
- sew the name
- machine stops when the name is complete

A

Program name in double capitals (B)

- activate pattern end
- sew
- machine stops when the name is complete

SE

Program initials and year in italics (C)

- activate pattern end
- sew
- machine stops when the sewing is finished
- trim connecting threads

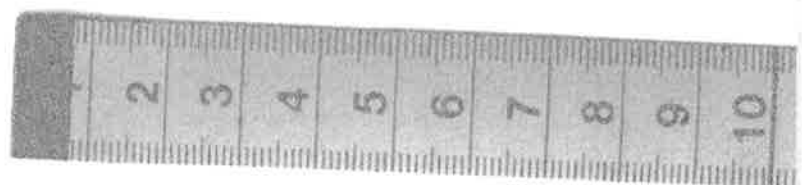

TIP

Activate pattern end after programming

- the programmed words will be repeated if the function is not activated

Sewing letters on double fabric

- bottom layer does not pucker

Sewing letters on single fabric

- always use stabilizer as a backing
- remove after sewing

Practical stitch seams

Open seams

- Seams which are pressed open
- seam allowance width as wide as wanted
 - seam lies flat
 - seam does not stretch open

- Suggested stitches:
- straight, narrow zig-zag and super stretch
- Application: primarily for woven fabrics
- clothing

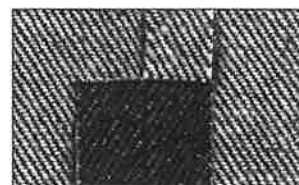

Closed seam (overlock seams)

- Seams which cannot be pressed open
- sewn and neatened in one operation
 - narrow seam allowances

- Suggested stitches:
- vari-overlock, double overlock
- Application: primarily for knits and jerseys
- excellent for knit clothing, lingerie and bed linens

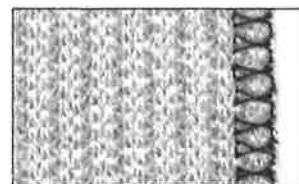

Flat joining seams

- Seams where the edges are overlapped and then over-sewn
- sewing is on the seam allowances

- Suggested stitch:
- stretch-overlock
- Application: particularly good for towelling and lycra

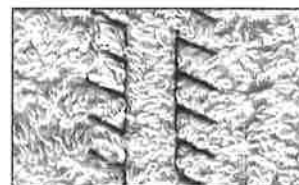

Zig-zag seam



- Stitch: **Zig-zag No. 2**
 Stitch width: **approx. 1 mm**
 Stitch length: **approx. 0,5 mm**
 Needle: **universal, ballpoint or stretch as needed**
 Thread: **cotton or polyester**
 Feed-dog: **up (sewing position)**
 Presser foot: **Reverse pattern foot No. 1**

Open seam applications

- stitch has more "give" than a straight stitch
- use for knits and outer wear
- seam lies flat and is not bulky
- allows a garment to be let out

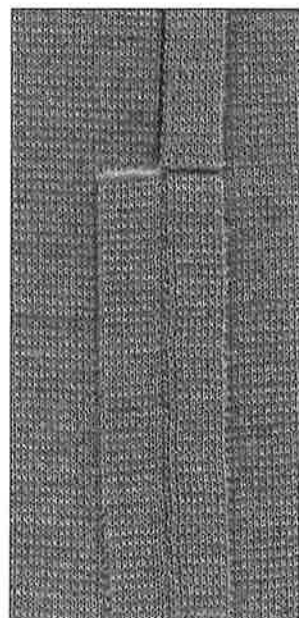

TIP

Seam in jersey or knits waves

- to prevent the stretching of the seam while being sewn, reduce the presser foot pressure to suit the fabric

Triple straight stitch seam



Stitch: **Triple straight stitch No. 6**
 Needle: **80–90 universal or jeans**
 Thread: **cotton or polyester**
 Feed-dog: **up (sewing position)**
 Presser foot: **Reverse pattern foot No. 1**

Open seam

- strong seam for firm and densely woven fabric such as denim and corduroy
- reinforced seam for garment areas subject to hard wear

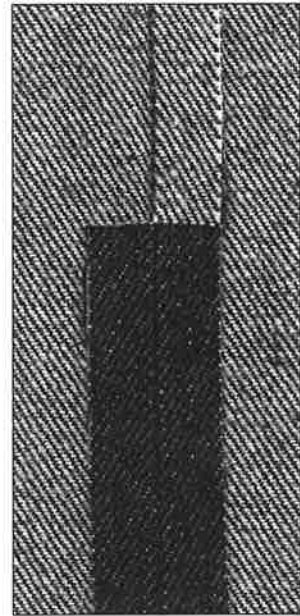

TIP

Use a Jeans needle and the jeans foot No. 8 for densely woven fabrics

Super stretch seam



Stitch: **Super stretch No. 13 virtuosa QE/No. 15 virtuosa plus**
 Needle: **universal, ballpoint or stretch as needed**
 Thread: **cotton or polyester**
 Feed-dog: **up (sewing position)**
 Presser foot: **Reverse pattern foot No. 1**

Open seam

- flexible seam for very stretchy fabrics, particularly for sports and leisure wear
- seam lies flat and is not bulky

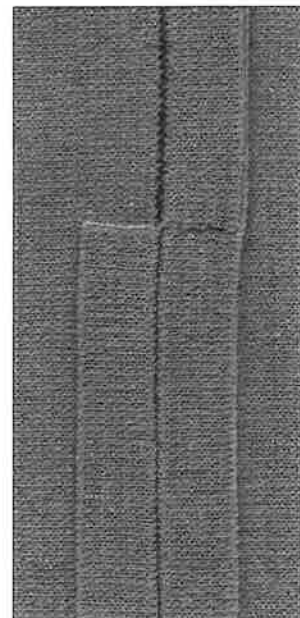

TIP

Knits and jersey

- use a new ball point needle to prevent damaging the loops

Sewing stretch fabrics

- if necessary use a stretch needle (130/705H-S) = needle point slides between the fibers

Seam in knits or jersey waves

- reduce presser foot pressure to suit the fabric

Vari-overlock seam



Stitch: **Vari-overlock No. 3**
 Needle: **size and type suitable for the fabric selected**
 Thread: **cotton or polyester**
 Feed-dog: **up (sewing position)**
 Presser foot: **Overlock foot No. 2 (optional) or Reverse pattern foot No. 1**

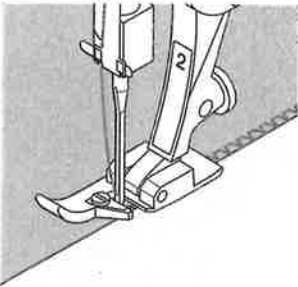

Closed seam

stretchy seam in fine, soft knits such as silk jersey and interlock

Sewing

- guide the raw edge along the pin on the overlock foot
- the stitch will form over the pin and over the edge of the fabric



TIP

Knits and jersey

- use a new needle to prevent damaging the loops

Sewing stretch fabrics

- if necessary use a stretch needle (130/705H-S) = needle point slides between the fibers

Double overlock seam



Stitch: **Double overlock No. 8**
 Needle: **size and type suitable for the fabric selected**
 Thread: **cotton or polyester**
 Feed-dog: **up (sewing position)**
 Presser foot: **Overlock foot No. 2 (optional) or Reverse pattern foot No. 1**

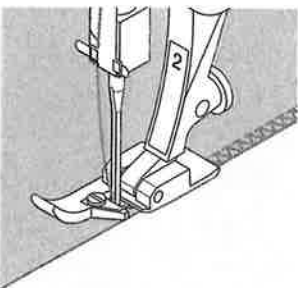

Closed seam

overlock seam in loose knits and cross seams in knits and jerseys

Sewing

- guide the raw edge along the pin on the overlock foot
- the stitch will form over the pin and over the edge of the fabric

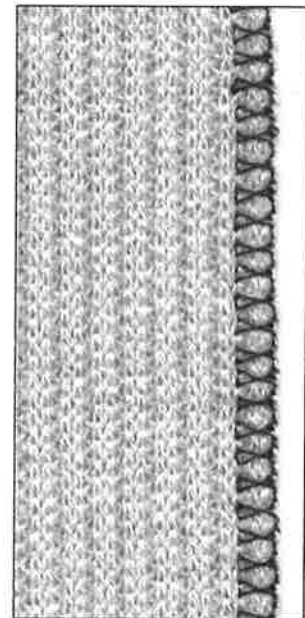

TIP

Knits and jersey

- use a new needle to prevent damaging the loops

Sewing stretch fabrics

- if necessary use a stretch needle (130/705H-S) = needle point slides between the fibers

Stretch overlock seam

TTTTT

Stitch: **Stretch overlock No. 16 virtuosa QE/No. 18 virtuosa plus**
 Needle: **size and type suitable for the fabric selected**
 Thread: **cotton or polyester**
 Feed-dog: **up (sewing position)**
 Presser foot: **Reverse pattern foot No. 1**

Closed seam

overlock seam in coarse or loose knits

Sewing

- sew stretch overlock along the fabric edge
- the stitch on the right swing should go over the edge of the fabric

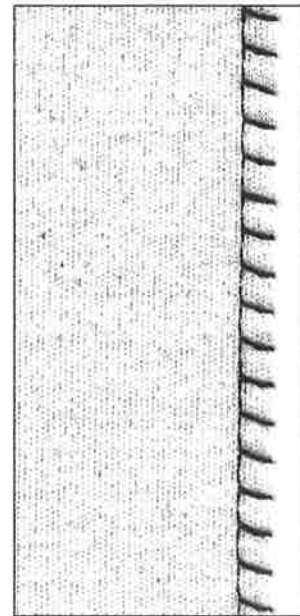

TIP

Seam in loose knits waves

- reduce presser foot pressure to suit the fabric

Flat joining seam

TTTTT

Stitch: **Stretch overlock No. 16 virtuosa QE/No. 18 virtuosa plus**
 Needle: **size and type suitable for the fabric selected**
 Thread: **cotton or polyester**
 Feed-dog: **up (sewing position)**
 Presser foot: **Reverse pattern foot No. 1**

Flat joining seam

- lay the fabric edges on top of each other and sew along the seam allowance = very flat, durable seams
- ideal for fluffy or thick materials such as towelling, felt and leather

Sewing

- sew stretch overlock along the fabric edge
- the stitch should go just over the edge of the top fabric into the lower layer

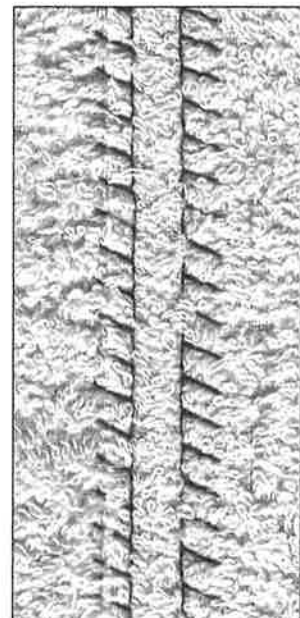

TIP

Fabric and thread

- if you use a matching color thread, it is hardly visible in fluffy fabrics

Thick seam

- particularly suitable for fabrics in which a normal straight stitch seam would stretch open

14 **Hems with practical stitches**

Preparation

- press hem and baste if desired

Sewing

- sew hem at desired depth (right side)
- trim surplus fabric (wrong side)

Visible hem with Jersey stitch



- Stitch: **Jersey stitch No. 15 virtuosa QE/No. 17 virtuosa plus**
- Needle: **universal, ballpoint or stretch as needed**
- Thread: **cotton or polyester**
- Feed-dog: **up (sewing position)**
- Presser foot: **Reverse pattern foot No. 1**

Visible stretch hem

for all types of cotton, wool, synthetic and mixed fiber jersey



TIP

Knits and jersey

- use a new ball point needle to prevent damaging the loops

Sewing stretch fabrics

- if necessary use a stretch needle (130/705H-S) = needle point slides between the fibers

Visible hem with Triple zig-zag stitch



- Stitch: **Triple zig-zag No. 6**
- Stitch width: **2,5–5 mm depending on fabric**
- Stitch length: **basic setting**
- Needle: **universal or jeans**
- Thread: **cotton or polyester**
- Feed-dog: **up (sewing position)**
- Presser foot: **Reverse pattern foot No. 1**

Strong visible seam

for firm, densely woven fabrics, particularly good for denim and canvas

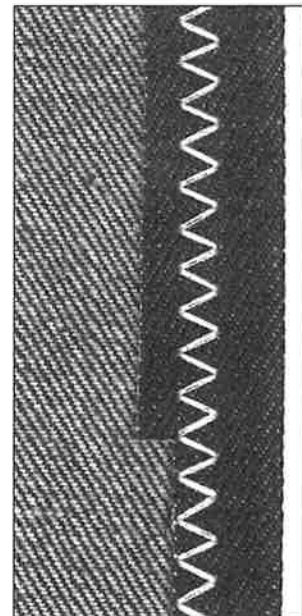

TIP

Hems on items which are to be washed frequently

- first neatens raw edges and do not trim after sewing

Sewing firm, densely woven fabrics

- use a Jeans needle

Sewing knits

Important information

Perfect needle

- blunt needles can damage knits

Use a stretch needle (130/705 H-S) if necessary

- the needle point slides between the fibers

Fine sewing thread

- heavy threads can damage knits and cause holes when the garment is washed

Darning thread for basting

- it's easier to remove when oversewn

Sewing test, when necessary

- the elasticity of modern fabrics varies greatly
- adjust basic settings to suit the fabric; the seam should be as stretchy as the fabric
- for greater elasticity:
 - use a shorter stitch length and a wider stitch width (only one of these adjustments may be necessary)

Presser foot pressure

- soft, loose knits can wave when sewn:
 - reduce the pressure until the seam lies flat;
 - the machine must still feed the fabric properly

Self-facing with Honeycomb stitch



Stitch: **Honeycomb No. 14 virtuosa QE/No. 16 virtuosa plus**
 Needle: **universal, ballpoint or stretch as needed**
 Thread: **cotton or polyester**
 Feed-dog: **up (sewing position)**
 Presser foot: **Reverse pattern foot No. 1**

Ribbing with visible seam

for all cotton, wool, synthetic and mixed fiber jersey

Preparation

- press 1 cm (3/8") to wrong side

Sewing

- sew from the right at a foot's width from the edge
- trim surplus fabric (wrong side)

Balance/corrections

- Honeycomb stitch is not closed
 - bring stitch together
 - = **adjust balance – (subtract space between stitches)**



- open out stitch
- = **adjust balance + (add space to stitches)**

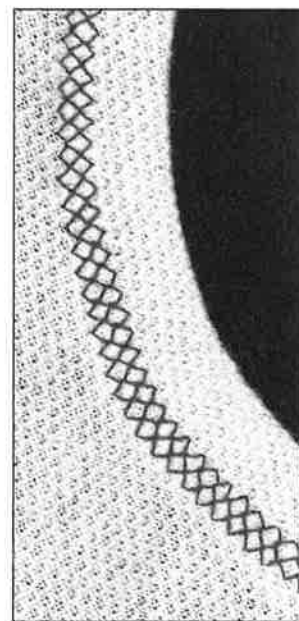

TIP

Needle stop down

- needle stays in fabric when you stop to adjust the ribbing

Presser foot pressure

- reduce pressure if hem stretches

16 Ribbing with overlock seam



Stitch: **Vari-overlock No. 3**
Needle: **size and type suitable for the fabric selected**
Thread: **cotton or polyester**
Feed-dog: **up (sewing position)**
Presser foot: **Overlock foot No. 2 (optional) or Reverse pattern foot No. 1**

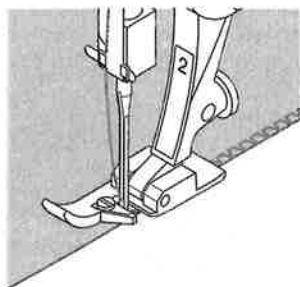

Ribbing with overlock seam
for all fine cotton, synthetic and mixed fiber jersey

Preparation
· fold ribbing in half
· pin and baste to opening, right side outside

Sewing
· sew Vari-overlock over the raw edge
· guide the edge along the pin on the foot



TIP

Needle stop down

- needle stays in fabric when you stop to adjust the ribbing

Zippers

Stitch: **Straight stitch No. 1**
 Needle: **size and type suitable for the fabric selected**
 Thread: **cotton or polyester**
 Feed-dog: **up (sewing position)**
 Presser foot: **Zipper foot No. 4**
 Needle position: **far right or far left**

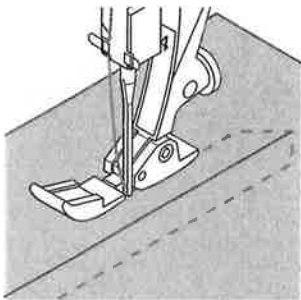

Preparation:

- baste in zipper
- fabric edges should meet over the center of the zipper

Sewing

- sew in the zipper, each side from bottom to top
- once with needle position far right and once with needle position far left
- the edge of the foot runs along the teeth of the zip
- the needle inserts close to the teeth

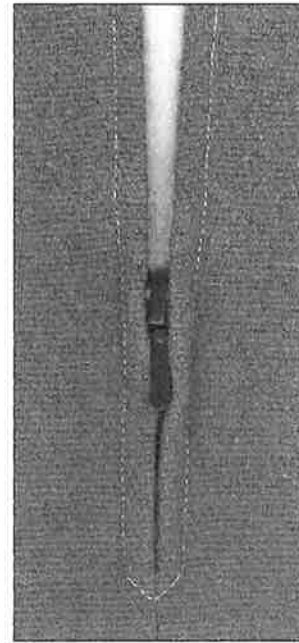

TIP

To sew around zipper pull

- close zipper and sew up to about 5 cm (2") away from the pull
- insert needle, raise the presser foot, open the zipper, lower the foot and continue to sew

Seam begin

- hold thread firmly when starting to sew = pull fabric slightly to the back (fewer stitches)

Zipper or fabric is thick or densely woven

- use a 90–100 needle for even stitch formation

Blind hem



Stitch: **Blind hem No. 7**
Needle: **size and type suitable for the fabric selected**
Thread: **cotton or polyester**
Feed-dog: **up (sewing position)**
Presser foot: **Blind stitch foot No. 5**

Blind hem

for invisible hems in medium to heavy cotton, wool and blended fabrics

Preparation

- neaten raw edges
- prepare seam as for sewing by hand
- place work under the presser foot (see drawing)

Sewing

- the needle should just pierce the edge of the fold (same as hand sewing)
- adjust the stitch width to suit the fabric
- after sewing about 10 cm (4"), check both sides of fabric and adjust width again if necessary

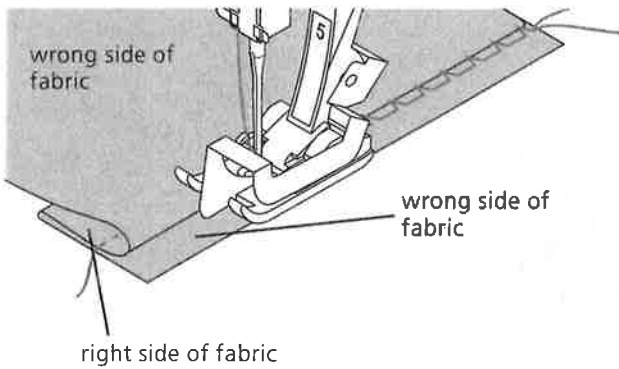

TIP

Fine stitch width adjustment

- guide the folded edge evenly along the metal guide on the foot = even depth

Sewing on narrow elastic with Universal stitch

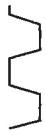

Stitch: **Universal stitch No. 19 (160 only)**
 Stitch width: **depending on width of elastic**
 Needle: **size and type suitable for the fabric selected**
 Thread: **cotton or polyester**
 Feed-dog: **up (sewing position)**
 Presser foot: **Reverse pattern foot No. 1 or Embroidery foot No. 6 (optional)**

Sewing on elastic

- for gathering long lengths of fabric, frills and flounces in fine fabrics
- works well for gathered sleeve edges and neck openings

Preparation

- cut elastic to length required

Sewing

- oversew the elastic, adjusting the stitch width to be slightly wider than the elastic
- needle must not pierce the elastic
- after sewing, adjust the gathers evenly

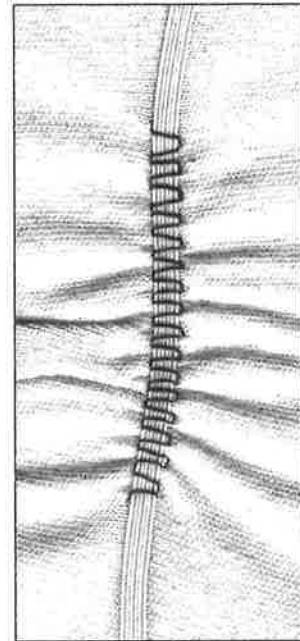

TIP

Secure the beginning and end of elastic

- sew a few straight stitches backward and forward to secure the elastic

Quick hem finish

- for children's or doll's clothing
- sew hem with elastic before sewing side seams

Sewing on shirring elastic/cord with Gathering stitch



Stitch: **Gathering stitch No. 20 (160 only)**
 Needle: **size and type suitable for the fabric selected**
 Thread: **cotton or polyester**
 Feed-dog: **up (sewing position)**
 Presser foot: **Buttonhole foot No. 3**

Shirring elastic/cord

for gathering long lengths of fabric

Preparation

- cut elastic/cord double the length of the fabric
- fold in half
- hook over the center prong on the buttonhole foot
- take both ends under the foot to the back

Sewing

- sew a few stitches
- lift elastic/cord at the front and pull towards you
- leave ends behind the presser foot
- oversew cord
- after sewing pull the cord to gather the fabric
- stretch elastic while sewing, the tighter it is stretched, the tighter the gathers

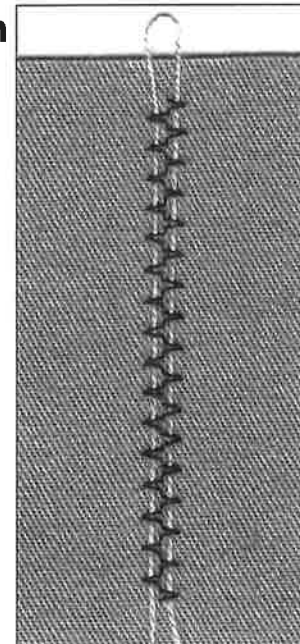

TIP

Securing beginning and end

- sew a few stitches with the feed-dog lowered

Sewing on wide elastic with Running stitch



Stitch: **Running stitch No. 4**
 Stitch length: **adjust to suit elastic**
 Needle: **size and type suitable for the fabric selected**
 Thread: **cotton or polyester**
 Feed-dog: **up (sewing position)**
 Presser foot: **Reverse pattern foot No. 1**

Wide elastic

for finishing openings on sports wear and lingerie

Preparation

- cut elastic to length required
- divide opening and elastic into 4 equal sections and mark
- pin elastic to opening, matching up markings

Sewing

- as you sew, stretch the elastic to fit the opening
- trim surplus fabric

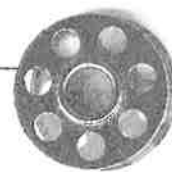
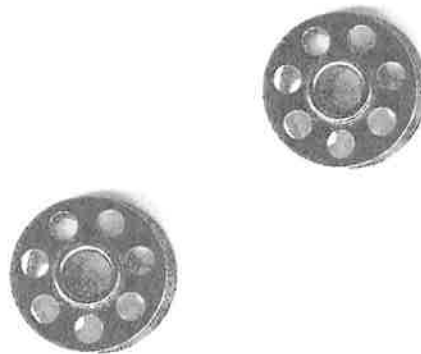
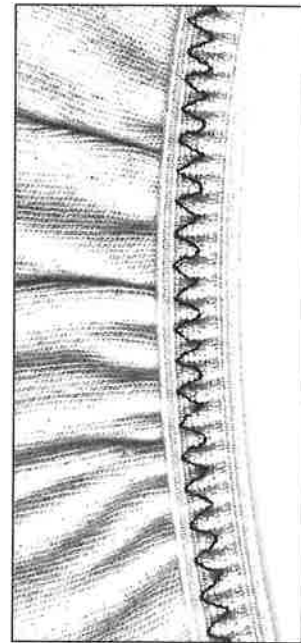

TIP

Gather the fabric edge first

- first sew two rows of straight stitching (stitch length 5 mm) 5–10 cm long
- knot threads at seam begin
- pull bobbin threads, gather fabric
- elastic band can be sewn over gathered fabric without stretching elastic
- an evenly gathered edge is completed

Elastic is stretched

- reduce the presser foot pressure to suit fabric and elastic

Everything you need to know about buttonholes

Thread tension

- thread the bobbin thread through the finger of the bobbin case
- the bobbin tension is a little tighter
- this gives the beads on the right side of the fabric a slightly rounded appearance
- the buttonhole looks more attractive
- gimp reinforces buttonholes and enhances their appearance (pages 26, 27)

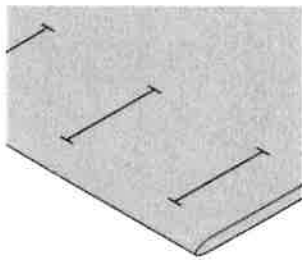

Mark the length of manual buttonholes

- mark the buttonhole length in the appropriate position
- stitched using Buttonhole foot No. 3

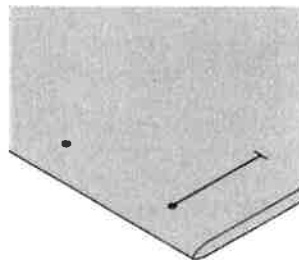

Mark the length of automatic buttonholes

- mark the length of just one buttonhole
- after sewing the first buttonhole, the length for all subsequent buttonholes is automatically programmed
- mark only the beginning of all subsequent buttonholes

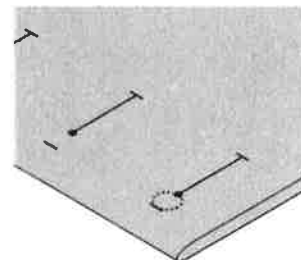

Mark the length of keyhole buttonholes

- mark the bead length only
- the correct length eye will be added when the buttonhole is sewn

Test sewing

- always test sew on the fabric and stabilizer you intend to use
- select the buttonhole type you intend to use
- sew the buttonhole in the same direction on the fabric (with or against the grain)
- cut the buttonhole open
- push the button through and adjust the buttonhole length if necessary

Corrections

- To adjust the bead width:
- alter the stitch width

Altering the stitch length:

- any alterations to the stitch length affect both beads (denser or less dense)
- **always reprogram the buttonhole after any changes to the stitch length**

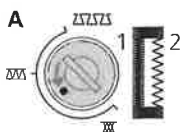

1. Denser bead
2. Finer bead

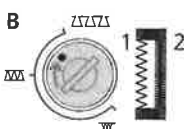

1. Finer bead
2. Denser bead

Balance for stitch counter buttonholes (pictures A + B)

- any alterations to the balance affect both beads
- if you alter the bead density with balance, delete the programmed buttonhole with the clr/del button and reprogramme the buttonhole with the new balance setting

Balance for automatic/manual buttonholes

- any balance alterations to the 6-step manual and auto length buttonholes affects both beads identically because they are sewn in the same direction

Note:

When all buttonholes have been sewn, return balance to the normal setting

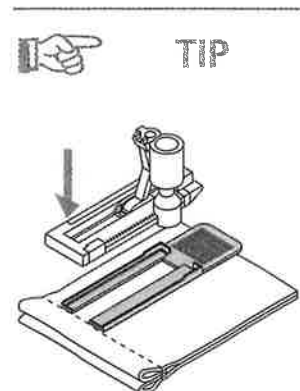

If a buttonhole is to be sewn at right angles to a seam, we recommend the use of the buttonhole leveler. Insert the plate from behind between the fabric and the foot up to and over the thicker area.

Manual buttonhole (all types)

The number of steps depends on the type of buttonhole selected.

A manual buttonhole cannot be saved.

Stitch: **any buttonhole**
 Needle: **size and type suitable for the fabric selected**
 Thread: **cotton or polyester**
 Feed-dog: **up (sewing position)**
 Presser foot: **Buttonhole foot No. 3**

Preparation

- select the desired buttonhole
- screen shows:
 - buttonhole number
 - presser foot No. 3
 - the buttonhole symbol (the first step blink on the screen)
- insert the lower thread in the finger of the bobbin case

Always test sew buttonholes

- test on the fabric and stabilizer you intend to use
- sew buttonholes in the same grain direction (with or against)

The individual steps blink on the screen

Sewing a standard buttonhole

1. sew the first bead forward, stop the machine
 - press the quick reverse button
2. sew reverse straight stitch, stop the machine at the first stitch (buttonhole begin)
 - press the quick reverse button
3. sew the bartack and the second bead, stop the machine
 - press the quick reverse button
4. sew the bartack and the securing stitches

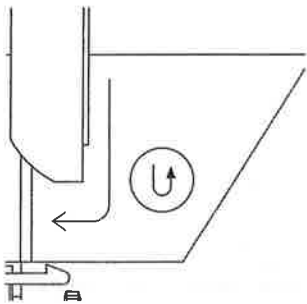
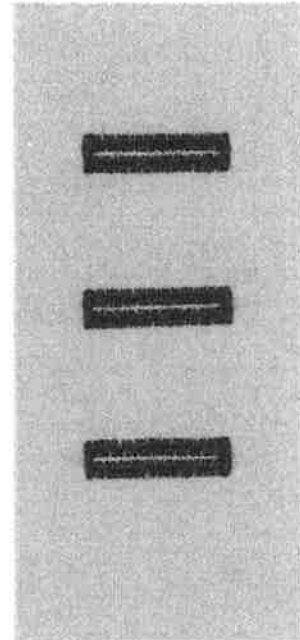

Automatic buttonholes

(without stitch counter buttonhole)

Both beads are sewn in the same direction.

Stretch buttonholes (virtuosa plus) are particularly effective on all knit fabrics because the double overlock stitch used for the beads stretch with the fabric while keeping its shape.

Note: The automatic buttonhole foot 3A must lie perfectly flat on the fabric. If the foot lies on a seam, the length cannot be measured accurately.

Stitch: **Buttonhole (all types)**
 Needle: **size and type suitable for the fabric selected**
 Thread: **cotton or polyester**
 Feed-dog: **up (sewing position)**
 Presser foot: **Automatic buttonhole foot No. 3A**

Automatic buttonhole

- the lens on automatic buttonhole foot 3A automatically registers the length of the buttonhole for exact duplication

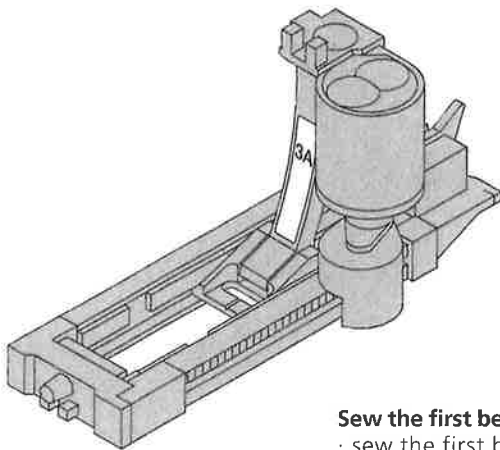

Sew the first bead

- sew the first bead forward, stopping at the desired length

Program the buttonhole

- press and release the quick reverse button
- auto appears on the screen to indicate that the buttonhole length is programmed
- continue sewing; the machine completes the buttonhole and stops automatically

Auto buttonhole

- machine stops in position to begin the next buttonhole
- reposition the fabric and sew; all subsequent buttonholes will be sewn automatically to the same length (without pressing the quick reverse button)

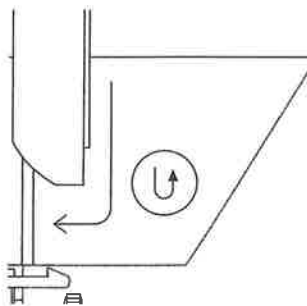

TIPS

Exact duplicates

- the auto function ensures that each buttonhole will be exactly the same length as the previous one

Marking

- mark only the beginning of the buttonholes – a real time saver!

Sewing speed

- sew at moderate speed for best results
- sew all buttonholes at the same speed for a consistent bead density

24 **Automatic keyhole buttonhole****(without stitch counter buttonhole)**

Both beads are sewn in the same direction.
The length of the beads is determined and the keyhole sections are sewn additional.



Stitch: **Keyhole buttonhole No. 10 (virtuosa QE)/
No. 12 (virtuosa plus)**
Needle: **size and type suitable for the fabric selected**
Thread: **cotton or polyester**
Feed-dog: **up (sewing position)**
Presser foot: **Automatic buttonhole foot No. 3A**

Automatic buttonhole

- the lens on automatic buttonhole foot 3A automatically registers the length of the buttonhole for exact duplication

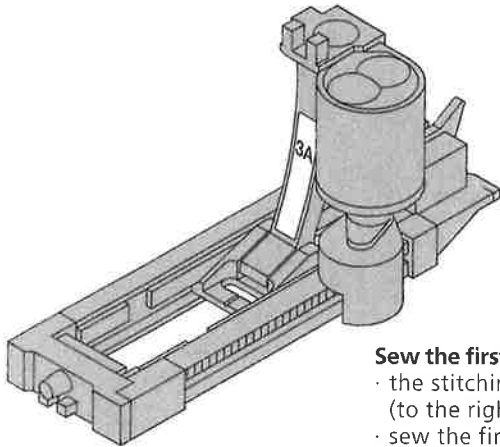
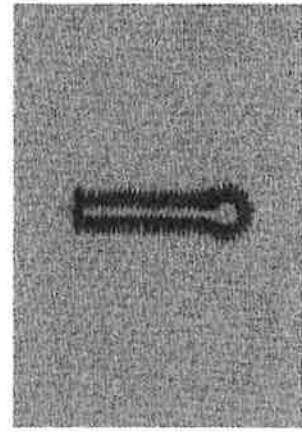
**Sew the first bead**

- the stitching sequence is displayed on the screen (to the right of the presser foot symbol)
- sew the first bead forward, stopping at the desired length

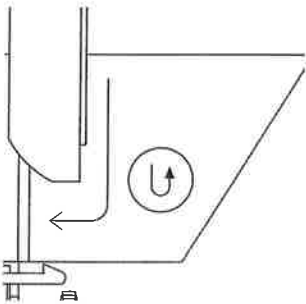
**Program the buttonhole**

- press and release the quick reverse button
- auto appears on the screen to indicate that the buttonhole length is programmed
- continue sewing; the machine completes the buttonhole and stops automatically

Auto buttonhole

- machine stops in position to begin the next buttonhole
- reposition the fabric and sew; all subsequent buttonholes will be sewn automatically to the same length (without pressing the quick reverse button)

**TIPS****Exact duplicates**

- the auto function ensures that each buttonhole will be exactly the same length as the previous one

Marking

- mark only the beginning of the buttonholes – a real time saver!

Double sewn keyhole buttonholes

- keyhole buttonholes can be sewn twice on thick fabrics
- after sewing the first buttonhole, do not move the work
- simply tap the foot control once to begin sewing again

Stitch counter buttonholes for all buttonhole types

(can not be saved in long term memory)

Stitch: **Buttonholes (all types)**
 Needle: **size and type suitable for the fabric selected**
 Thread: **cotton or polyester**
 Feed-dog: **up (sewing position)**
 Presser foot: **Buttonhole foot No. 3**



The first (left) bead is sewn forwards, the second (right) bead is sewn in reverse.

Stitch counter buttonholes

- select the desired buttonhole
- press the continuous reverse button (stitch counter buttonhole selector)

Length of first bead

- sew the first bead, stopping at the desired length
- press and release the quick reverse button

Bartack, second bead

- bottom bartack and second bead are sewn in reverse
- stop machine at the first stitch
- press and release the quick reverse button

Bartack, securing stitches

- machine sews the top bartack and securing stitches
- machine stops automatically
- auto appears on the screen
- the buttonhole is programmed and saved
- each subsequent buttonhole will be sewn identically

Corrections

- reprogram the buttonhole if any alterations to the stitch width, length, or balance have been made

Programmed buttonhole on a different fabric

- different fabrics and interfacings can affect the look of a stitch counter buttonhole
- if you are using a new material, program the buttonhole again
- test sewing on the new fabric is recommended

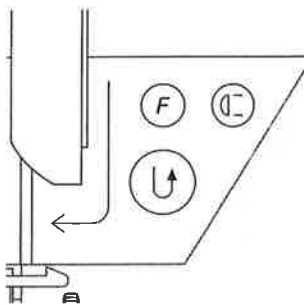

TIPS

More buttonholes with presser foot No. 3

- ideal for buttonholes which are difficult to sew with the larger foot of Automatic buttonhole foot 3A

Beautiful buttonholes

- keep the speed consistent for beads of equal density
- sew at a moderate speed for best results

Marking

- mark only the beginning of the buttonholes – a real time saver!

Standard and stretch* buttonholes with gimp (*virtuosa 160 plus only)

Gimp

- gimp cord reinforces buttonholes and enhances their appearance
- the loop of the cord should be at the end of the buttonhole most subject to wear
- cord loop = where button is sewn on
- position the work accordingly
- gimp cord is particularly recommended for standard and stretch buttonholes

Ideal cords

- Perle yarn No. 8
- strong hand sewing thread
- fine crochet yarn

Hooking the cord onto presser foot No. 3

- insert the needle at the beginning of the buttonhole
- raise the presser foot
- hook the cord over the centre pin on the front of the foot

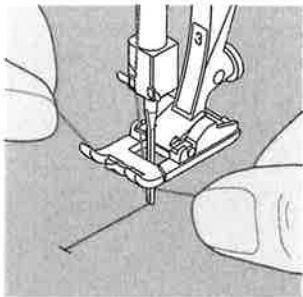

- place both ends of the cord in the grooves on the sole of the foot and pull them to the back
- lower the presser foot

Sewing

- sew the buttonhole in the usual manner
- do not hold the cord tightly
- the buttonhole will form over the cord, covering it

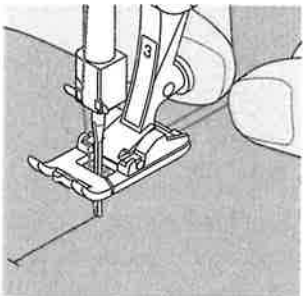

Hooking the cord in the buttonhole foot with slide No. 3A

- insert the needle at the beginning of the buttonhole
- raise the presser foot
- guide the cord under the foot to the right
- hook the cord over the pin at the back of the foot

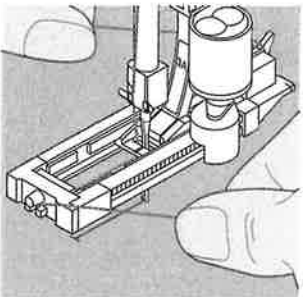

- bring the cords to the front of the foot
- pull them into the slit
- sew the buttonhole

Sewing

- sew the buttonhole in the usual manner
- do not hold the cord tightly
- the buttonhole will form over the cord, covering it

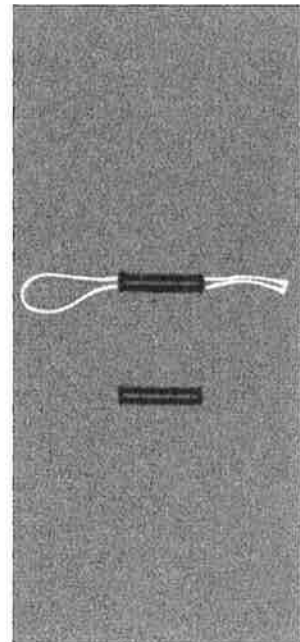
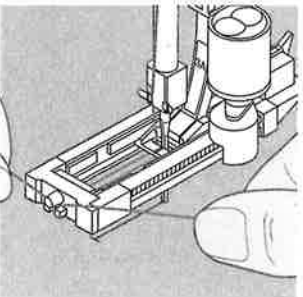

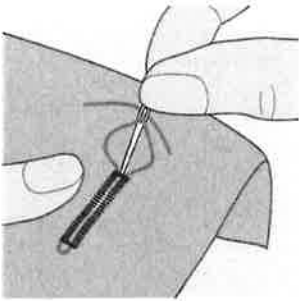
**Securing the cord**

- pull the cord through the buttonhole
- pull cords through to back of fabric
- knot or secure with stitches

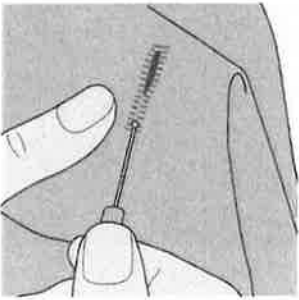
**Cutting buttonholes open**

- using the seam ripper, cut from the ends towards the middle

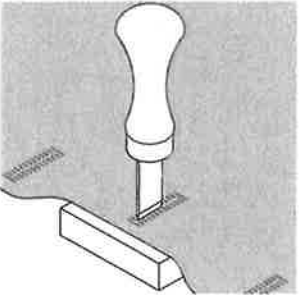
**Buttonhole cutter and block (special accessory)**

- place the fabric on the wood
- place the cutter in the centre of the buttonhole
- press down on the cutter with your hand or a hammer

Eyelet

Stitch: **Eyelet No. 13**
 Needle: **size and type suitable for the fabric selected**
 Thread: **cotton or polyester**
 Feed-dog: **up (sewing position)**
 Presser foot: **Reverse pattern foot No. 1**

Sewn eyelet

- opening for cord and narrow ribbon
- for decorative work, children's clothing, crafts

Sewing eyelets

- select eyelet
- sew program
- machine stops automatically
- machine is ready to sew the next eyelet

Cutting eyelets open

- use an eyelet punch

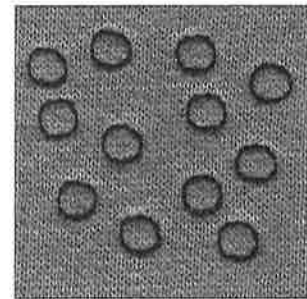
**TIP****Eyelets**

- ideal as eyes for soft toys, dolls or puppets

More marked appearance

- thread bobbin thread in finger on bobbin case = tighter bobbin tension

28 Hand-look quilt stitch

- Stitch: **Quilt stitch No. 21 (virtuosa QE) No. 26 (virtuosa plus)**
- Needle: **size and type suitable for the fabric selected**
- Upper thread: **monofilament**
- Bobbin thread: **30/2 cotton thread**
- Feed-dog: **up (sewing position)**
- Presser foot: **Reverse pattern foot No. 1 or walking foot No. 50 (optional)**

Quilt/hand stitch

for all fabrics and all types of work which should have a hand-sewn look

Sewing test

- the bobbin thread must come through to the right side
- 1 stitch is visible, 1 stitch is invisible (monofilament) = hand stitched effect

Upper thread tension

depending on the fabric = increase the tension (6–9)

Balance

adjust if necessary

Sewing

- Quilt stitch can be sewn with any needle position

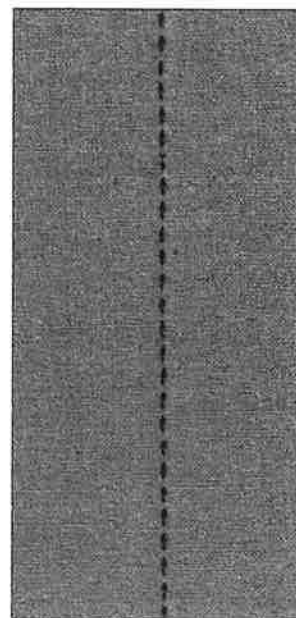

TIP

Perfect corners

- activate pattern end then turn work

Monofilament breaks

- sew more slowly
- reduce upper thread tension slightly

Patchwork foot

- Stitch: **Straight stitch No. 1**
- Needle: **size and type suitable for the fabric selected**
- Stitch length: **1,5 mm–max. 2 mm**
- Thread: **cotton or polyester**
- Feed-dog: **up (sewing position)**
- Presser foot: **Patchwork foot No. 37**

Patchwork foot

Accuracy is essential when sewing patches together. The Patchwork foot is exactly ¼" wide, the centre indents on either side of the foot indicate the needle insertion point and the two additional indents are ¼" in front of and behind the needle. If you sew at a foot's width, the seam allowances will always be exactly ¼" wide and it is easy to turn the work while maintaining the same width.

A stitch length of 1,5–2 mm is ideal.

It is not necessary to secure the stitches for these relatively short seam lengths. Attach the sewing table for precise and easier work.

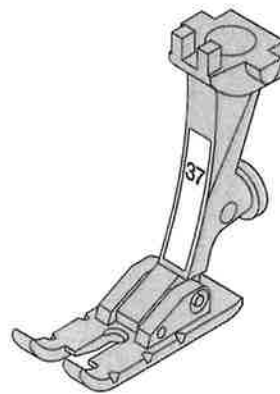

Freehand quilting

Stitch: **Straight stitch No. 1**
 Needle: **size and type suitable for the fabric selected**
 Thread: **cotton or monofilament**
 Feed-dog: **down (darning position)**
 Presser foot: **Darning foot No. 9 or Quilting foot No. 29 (optional)**

Freehand quilting

- for all freehand quilt work

Preparation

- pin and baste top layer, batting, and lining together
- attach the slide-on sewing table or place machine in a cabinet

Holding the work

- start in the center and work out toward the edges
- hold the fabric with both hands like an embroidery frame

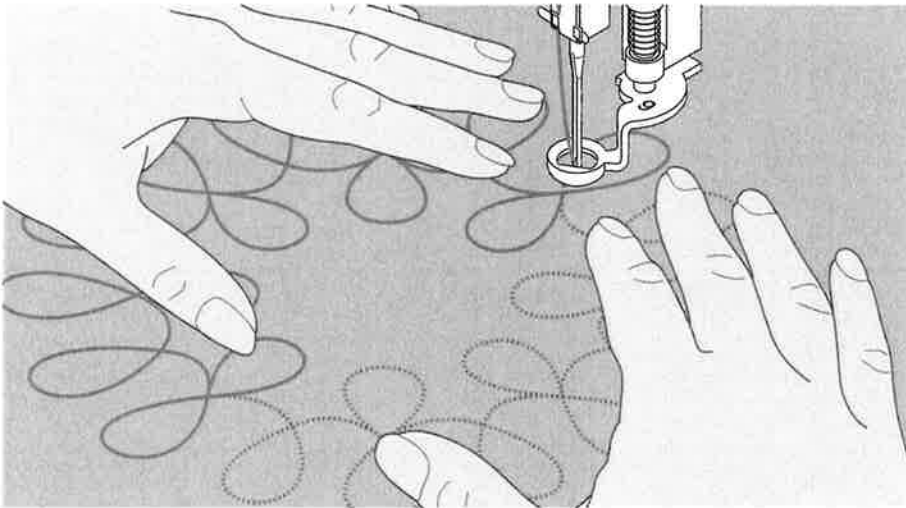
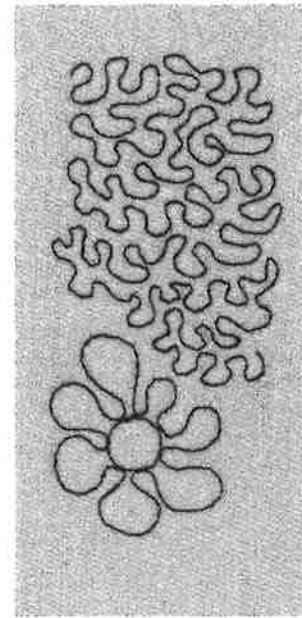

Quilting a design

- turn the work using smooth, round movements to form the design of your choice (either freehand or following a template)

Stipple quilting

- this technique covers the entire surface of the fabric
- the lines of stitching are rounded without any sharp corners; they never cross or touch one another



TIPS

Freehand quilting and darning

- both techniques are based on the same free-motion principles

Thread breaks

- usually as a result of sudden or jerky movements – move the fabric smoothly and at an even pace

Poor stitch formation

- if the thread forms loops, the work is being moved too quickly
- if knots are forming on the underside, the work is being moved too slowly

Monofilament hints

- if the monofilament thread breaks, sew more slowly and/or reduce the upper thread tension slightly

30 Edging knits with shirring elastic



- Stitch: **Zig-zag No. 2**
Stitch width: **approx. 5 mm**
Stitch length: **1–1,5 mm**
Needle: **size and type suitable for the fabric selected**
Thread: **cotton or polyester**
Feed-dog: **up (sewing position)**
Presser foot: **Reverse pattern foot No. 1**

Edges in knits with shirring elastic

prevents openings from stretching and helps retain their shape

Sewing

- guide double length of shirring elastic along the edge of the fabric
- stretch the elastic lightly
- oversew with zig-zag
- do not sew through the elastic, only over it
- adjust elastic after sewing is complete to regain the correct shape and size

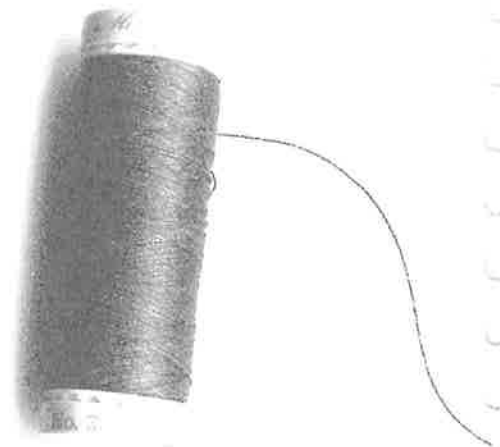

TIP

Stretch fabrics stretch while sewing

- reduce the presser foot pressure to suit the fabric

Patches on woven fabrics



Stitch: **Running stitch No. 4**
Honeycomb No. 14 (virtuosa QE)/No. 16 (virtuosa plus)
 Needle: **size and type suitable for the fabric selected**
 Thread: **cotton or polyester**
 Feed-dog: **up (sewing position)**
 Presser foot: **Reverse pattern foot No. 1**

Reinforcing edges

- good for work clothes, table linen, towels, etc.
- use a cord to match the color of the fabric

Suitable cords

- perle yarn
- fine crochet yarn
- strong hand-sewing thread
- gimp

Sewing

- oversew edges with Honeycomb or Running stitch
- oversew a cord along the edge for added reinforcement
- if necessary, sew a second row somewhat in from the edge

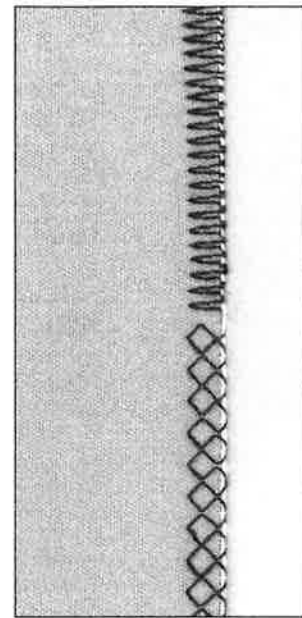

Patches on knits and jersey



Stitch: **Jersey stitch No. 15 (virtuosa QE)/No. 17 (virtuosa plus)**
 Needle: **size and type suitable for the fabric selected**
 Thread: **cotton or polyester**
 Feed-dog: **up (sewing position)**
 Presser foot: **Reverse pattern foot No. 1**

Disguises worn or damaged areas

particularly for stretchy fabrics, especially underwear

Preparation

- do not cut damaged area
- round off patch to retain elasticity
- pin and baste to right side

Sewing

- place patch over worn area
- sew over edge
- sew a second row inside the first if necessary
- cut away damaged area

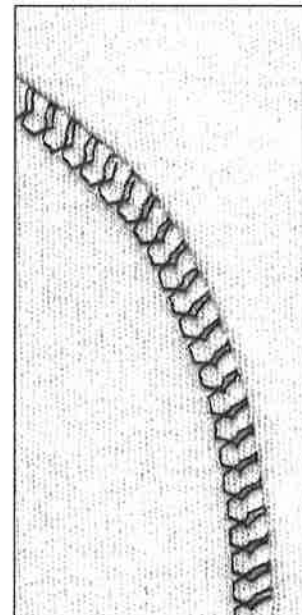

TIP

Knits

- use a new needle to prevent damaging the loops

Sewing stretch fabrics

- if necessary use a stretch needle (130/705 H-S) = needle slides between the fibers

Fabric stretches and waves

- reduce presser foot pressure to suit the fabric

Darning and mending tears with Running stitch



Stitch: **Running stitch No. 4**
 Needle: **size and type suitable for the fabric selected**
 Thread: **cotton or polyester**
 Feed-dog: **up (sewing position)**
 Presser foot: **Reverse pattern foot No. 1**

Quick mends

for tears and worn areas on all types of fabric

Preparation

- for tears use a fine backing fabric

Sewing

- tears: sew 3–5 rows of Running stitch
- worn areas: sew as many rows as necessary next to one another
- overlap each row slightly over the previous one

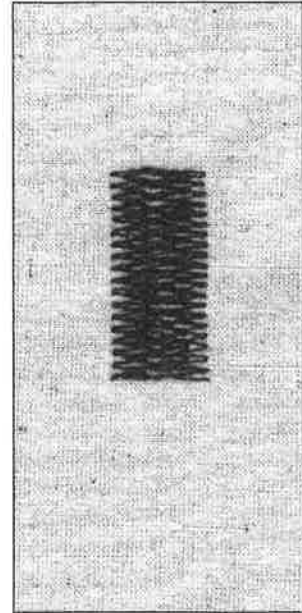

Method

flat areas

- sew forward
- insert needle
- turn work
- sew forward again

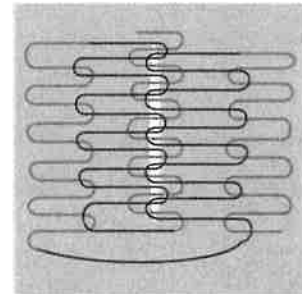

tubular areas (trousers, sleeves)

- sew first row forward
- select continuous reverse sewing function
- sew second row in reverse
- delete function
- sew next row forward again
- repeat as necessary

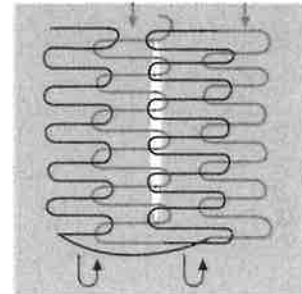

TIP

Backing for tears

- instead of fine fabric, use a piece of gauze or soft interlining

Darning program



Stitch: **Darning Program No. 12 (virtuosa QE)/
No. 14 (virtuosa plus)**
 Needle: **size and type suitable for the fabric selected**
 Thread: **darning thread**
 Feed-dog: **up (sewing position)**
 Presser foot: **Reverse Pattern foot No. 1
Buttonhole foot No. 3A**
 (available as a special accessory for virtuosa 150 QE)

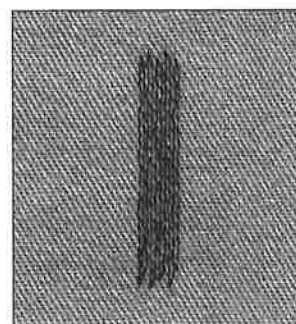

Quick darning of holes or worn areas

- replaces threads with the grain in all fabrics

Darning with Reverse Pattern foot No. 1



- select continuous reverse/stitch counter buttonhole selector
- insert the needle in the top left of the worn area
- sew the first vertical row
- press the quick reverse button at desired length
- continue sewing, machine stops automatically

Large areas:

The darning area can be extended by moving the work under the foot.

Clear the programme by pressing the clr/del button.

Darning with the Buttonhole foot with slide No. 3A

- insert the needle in the top left of the worn area
- sew the first vertical row
- press the securing button (length is programmed)
- complete the darning programme, the machine stops automatically
- the machine changes direction automatically for a darn of about 3 cm (1 1/2") in length
- the machine completes the darning programme automatically

Large areas:

The darning area can be extended by moving the work under the foot.

Clear the programme by pressing the clr/del button.

Corrections

- if the darning becomes distorted, correct with Balance



TIP

Reinforcement

- use fine fabric or interlining as a backing

Preparation

- stretch fabric into darning ring*
- prevents puckering

*The darning ring is available as special accessory

Darning manual

Stitch: **Straight stitch No. 1**
 Needle: **size and type suitable for the fabric selected**
 Thread: **darning thread**
 Feed-dog: **down (darning position)**
 Presser foot: **Darning foot No. 9 (optional)**

Darning holes or worn areas

replaces both lengthways and horizontal threads in all fabrics

Preparation

- stretch fabric into darning ring*
- prevents puckering
- if possible, use the sewing table**

Sewing

- move darning ring smoothly
- work from left to right
- move without using pressure

Method

- sew first row
- turn work by 90°
- sew over the first row – not too close for a soft finish
- turn work by 90° again
- complete darning loosely and in same direction as first row
- in tubular items
 first step in a horizontal direction
 second and third steps in lengthways direction
- when you have mastered the technique
 work the rows in irregular lengths so that the ends are lost in the fabric

Important

- change direction in curves (no points)
 = prevents holes
 = prevents thread breakage
- move as if writing L or M
- do not sew in circles = these do not mimic fabric construction

- * The darning ring is available as special accessory.
- ** virtuosa 150 QE optional

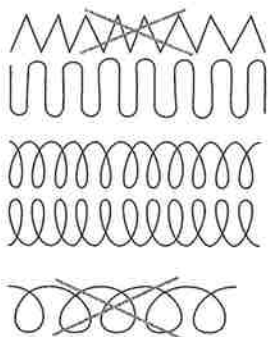
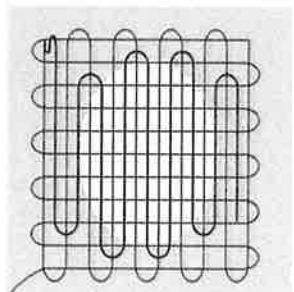
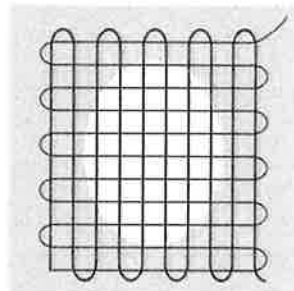
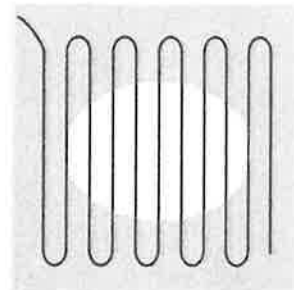
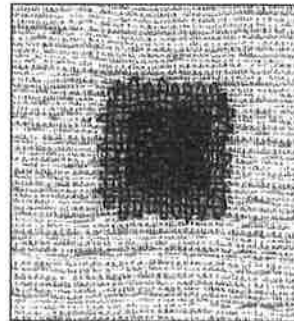

TIP

Thread breaks

- uneven movement of darning ring

Stitch formation is not good, thread lies on top

- ring moved too quickly

Knots on the underside

- ring moved too slowly

Index

B		F		N		T	
Blind hem	18	Flat joining seam	13	Numbers in memory	9	Triple straight stitch seam	11
Buttonhole		Freehand quilting	29				
· balance	21			P		V	
· cutting open	27	H		Patching	31	Vari-overlock seam	12
· functions	21	Hand stitches/ quilting stitch	28	Patchwork foot	28	Visible hem with Jersey stitch	14
· keyhole	24	Hems with practical stitches	14	Practical and decorative stitches in memory	8	Visible hem with Triple zig-zag stitch	14
· manual	22			Practical stitch seams	10		
· standard	23	J				Z	
· standard with gimp	26	Joining seam (flat)	13	Quilt stitch hand	28	Zig-zag seam	10
· stitch counter	25			Quilting freehand	29	Zig-zag stitch	5
· stretch	23	K				Zipers	17
· stretch with gimp	26	Keyhole buttonhole	24	R			
		Knits	15	Ribbing with overlock seam	16		
C							
Couching	19	L		S			
		Letters/numbers in memory	9	Securing stitch	3		
D				Self-facing with honeycomb stitch	15		
Darning with running stitch	32	M		Sewing knits	15		
Darning manual	34	Memory	8	Shirring elastic	19		
Darning Programme	33	Mending tears	30	Standard buttonhole	23		
Decorative stitches	6			Standard buttonhole with gimp	26		
Decorative stitches combined with functions	7			Straight stitch	2		
Double overlock seam	12			Stretch buttonhole	23		
				Stretch buttonhole with gimp	26		
E				Stretch overlock seam	13		
Edge stitching	4			Super stretch seam	11		
Edges on knits with elastic	30						
Elastic	19						
Elastic, sewing on	20						
Eyelet	27						

BERNINA
INTRODUCES THE
ONLY SEWING
MACHINE YOU
CUSTOMIZE TO
SIMPLIFY THE WAY
YOU SEW.

USE THIS VOUCHER
TODAY TO START
CUSTOMIZING YOUR
NEW BERNINA!

Nothing Sews Like A Bernina. Nothing.

BERNINA®



*V*OUCHER
*for one presser foot of
your choice*

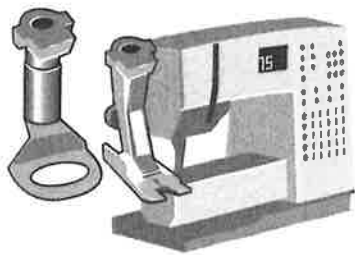

CUSTOMIZE. SIMPLIFY.
CREATE.

REDEEM THIS VOUCHER
AT YOUR BERNINA DEALER.

Nothing Sews Like A Bernina. Nothing.

BERNINA®



*V*OUCHER
*for one presser foot of
your choice*

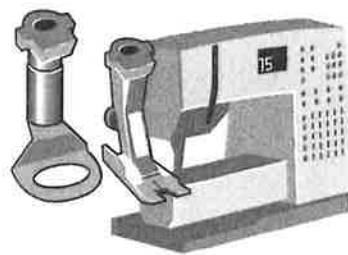

CUSTOMIZE. SIMPLIFY.
CREATE.

REDEEM THIS VOUCHER
AT YOUR BERNINA DEALER.

Nothing Sews Like A Bernina. Nothing.

BERNINA®

Nothing Sews Like A Bernina. Nothing.

BERNINA®

CUSTOMIZE. SIMPLIFY. CREATE.



Thank you for choosing Bernina, the only sewing machine that lets you customize to simplify the way you sew. Choose those accessories from an enticing range which suit your sewing style and requirements. You'll always be up to date! Your Bernina dealer will gladly tell you more.

"Welcome to
the BERNINA

family!"

H.P. Ueltschi

H.P. Ueltschi
President BERNINA
Sewing Machine Company

VOUCHER

In addition to the presser feet supplied with your machine, you can select an extra two from a choice of 15 special feet at no extra cost. Just hand this voucher to your local Bernina dealer.

Voucher handed in by:

Name

Street

Town / Zip code

Land

BERNINA model (chassis no.)

Presser foot choice (name / no.)

① _____ No. _____

BERNINA Dealer's stamp

Blank rectangular area for dealer's stamp.

008 606 5004

Voucher handed in by:

Name

Street

Town / Zip code

Land

BERNINA model (chassis no.)

Presser foot choice (name / no.)

① _____ No. _____

BERNINA Dealer's stamp

Blank rectangular area for dealer's stamp.

008 606 5004